



HP 8592A Portable Microwave Spectrum Analyzer Installation Manual

Serial Numbers

This manual applies directly to analyzers with serial numbers prefixed through 2736A

For additional important information about serial numbers, see "Analyzers Covered By This Manual" in Chapter 1

Manual Part Number: HP PN 08592-90003
Microfiche Part Number: 08592-90004
Printed in U.S.A., October 1987

Copyright © 1987 by Hewlett-Packard Company
1212 Valley House Drive, Rohnert Park, CA 94928-4999

HP 8592A Documentation Description

Manuals shipped with your analyzer: *You are here!*



Installation Manual*

HP Part Number 08592-90003

- Tells you how to install the spectrum analyzer
- Tells you what to do in case of a failure

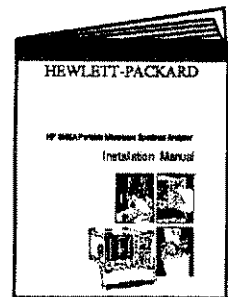

Operating Manual*

HP Part Number 08592-90005

- Tells you how to make measurements with your spectrum analyzer
- Describes analyzer features



Options:

Support Manual (HP 8592A Option 915)**

HP Part Number 08592-90008

- Describes troubleshooting and repair of the analyzer

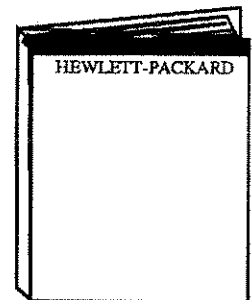

Programming Manual

HP Part Number: 08592-90010 (HP 8592A Option 021, 022, 023)

- Describes analyzer operation via a remote controller (computer)



* Additional copies of the Operating Manual and the Installation Manual are not available separately; together, they constitute the HP 8592A Documentation Package and must be ordered by its HP Part Number — 08592-90001.

** Option 915, Service Documentation (08592-90007), consists of one copy each of the Support Manual, the Installation Manual, and the Operating Manual.

How to Use This Manual

Where to Start

If you have just received the HP 8592A and want to get it ready to use for the first time:

Skim Chapter 1, "Introducing the Spectrum Analyzer," for a brief introduction to the unit and its capabilities.

Thoroughly read Chapter 2, "Preparation for Use," and follow its instructions for:

- unpacking the unit
- preparing it for use
- performing initial calibration routines and a confidence test to get a quick indication that the unit is ready for operation (these are automatic self-checks and require no test equipment).

If you need to verify the unit is operating within its specifications, perform the Operation Verification tests in Chapter 3, "Verifying Specified Operation."

Then use the Operating Manual to learn how to use the analyzer.

If the analyzer has been in use and you want to verify that it is operating correctly or to solve an apparent problem:

Perform the calibration routines and confidence test procedure given in Chapter 2, "Preparation for Use," for a quick indication of proper operation.

If you have the necessary test equipment, perform the Operation Verification tests in Chapter 3, "Verifying Specified Operation," to verify that the unit is operating within its specifications.

If there is an apparent problem, read Chapter 4, "If Something Goes Wrong ...," for hints on what may be wrong and how to solve the problem, and instructions for calling HP for additional help.

Manual Terms and Conventions

Words in this manual that appear CAPITALIZED in [BRACKETS] refer to softkeys that appear on the screen. Keys that appear on the front panel of the instrument appear in ***BOLD ITALICS***.

Printing History

Each new edition of this manual incorporates all material updated since the previous edition. Manual change sheets may be issued between editions, allowing you to correct or insert information in the current edition.

The part number of this manual changes only when a new edition is published. Corrections or additions may be made as the manual is reprinted between editions.

Part Number 08592-90003

Printing: October 1987

Table of Contents

Documentation Description	2
How to Use This Manual	3
Where to Start	3
Manual Terms and Conventions	4
Printing History	4
Safety Symbols	7
General Safety Considerations	8
Electrostatic Discharge	9
Reducing Damage Caused by ESD	10
Static-Safe Accessories	10

1 Introducing the Spectrum Analyzer

What You'll Find in This Chapter	1-1
Introducing the Spectrum Analyzer	1-1
Options and Accessories Available	1-2
Options	1-2
Accessories	1-3
Analyzers Covered By This Manual	1-5
Serial Numbers	1-5
Specifications and Characteristics	1-6
Specifications	1-6
Characteristics	1-11

2 Preparation for Use

What You'll Find in This Chapter	2-1
Getting Ready	2-1
Initial Inspection	2-1
Preparing the Analyzer for Use	2-1
Setting the Line Voltage Selector Switch	2-3
Checking the Fuse	2-3
Power Cable	2-4
Power Requirements	2-4
Turning the Analyzer On for the First Time	2-6

Introduction

Preparation

3 Verifying Specified Operation

Verification

What You'll Find in This Chapter	3-1
What is Operation Verification?	3-1
Before You Start Operation Verification	3-2
Test Equipment You'll Need	3-2
Accessories You Should Have	3-2
Recording the Test Results	3-3
If the Analyzer Doesn't Meet Specifications	3-3
Periodically Verifying Operation	3-3
Verification Tests	3-6
Calibrator Amplitude and Frequency Accuracy	3-6
Displayed Average Noise	3-8
Frequency Span Readout Accuracy	3-12
Frequency Readout Accuracy	3-16
Frequency Response Flatness	3-18

4 If Something Goes Wrong . . .

Problems?

What You'll Find in This Chapter	4-1
Before You Call HP	4-2
Check the Basics	4-2
Read the Warranty	4-3
Service Options	4-3
How to Call HP	4-3
How to Return Your Analyzer for Service	4-6
Service Tag	4-6
Original Packaging	4-6
Other Packaging	4-7

Appendix A	
Screen Messages	A-1

Appendix B	
Service Requests	B-1

Index	Index-1
--------------	---------

Safety Symbols

The following safety symbols are used throughout this manual and in the instrument. Familiarize yourself with each of the symbols and its meaning before operating this instrument.



Instruction manual symbol. The instrument will be marked with this symbol when it is necessary for the user to refer to the instruction manual in order to protect the instrument against damage. Location of pertinent information within the manual is indicated by use of this symbol in the table of contents.



Indicates dangerous voltages are present. Be extremely careful.



CAUTION

The CAUTION symbol denotes a hazard. It calls attention to a procedure which, if not correctly performed or adhered to, could result in damage to or destruction of the instrument. Do not proceed beyond a CAUTION symbol until the indicated conditions are fully understood and met.



WARNING

The WARNING symbol denotes a hazard. It calls attention to a procedure which, if not correctly performed or adhered to, could result in injury or loss of life. Do not proceed beyond a WARNING symbol until the indicated conditions are fully understood and met.

General Safety Considerations

WARNING

BEFORE THIS INSTRUMENT IS SWITCHED ON, make sure it has been properly grounded through the protective conductor of the ac power cable to a socket outlet provided with protective earth contact. Any interruption of the protective (grounding) conductor, inside or outside the instrument, or disconnection of the protective earth terminal can result in personal injury.

WARNING

There are voltages at many points in the instrument which can, if contacted, cause personal injury. Be extremely careful. Any adjustments or service procedures that require operation of the instrument with protective covers removed should be performed only by trained service personnel.

CAUTION

BEFORE THIS INSTRUMENT IS SWITCHED ON, make sure its primary power circuitry has been adapted to the voltage of the ac power source. Failure to set the ac power input to the correct voltage could cause damage to the instrument when the ac power cable is plugged in.

Electrostatic Discharge

Electrostatic discharge (ESD) can damage or destroy electronic components. Therefore, all work performed on assemblies consisting of electronic components should be done at a static-free work station.

Figure 1 is an example of a static-safe work station using two types of ESD protection:

- conductive table mat and wrist-strap combination
- conductive floor mat and heel-strap combination

These methods may be used together or separately.

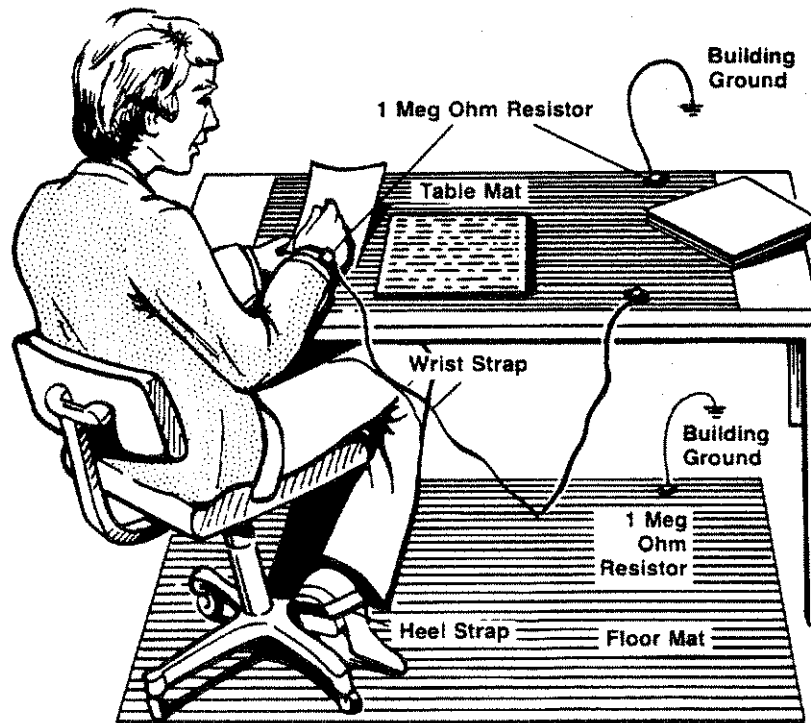

Figure 1. Example of a Static-Safe Work Station

Reducing Damage Caused by ESD

Following are suggestions that may help reduce ESD damage that occurs during testing and servicing operations.

- Before connecting any coaxial cable to an analyzer connector for the first time each day, momentarily ground the center and outer conductors of the cable.
- Personnel should be grounded with a resistor-isolated wrist strap before touching the center pin of any connector and before removing any assembly from the unit.
- Be sure that all instruments are properly earth-grounded to prevent a buildup of static charge.

Static-Safe Accessories

Table 1 lists static-safe accessories that can be obtained from Hewlett-Packard by using the HP part numbers shown.

Table 1. Static-Safe Accessories

HP Part Number	Description
Note: The following items can be ordered through any Hewlett-Packard Sales and Service office	
9300-0797	3M static control mat, 0.6m x 1.2m (2 ft x 4 ft) 4.6m (15 ft) ground wire wrist strap and attachment cord
9300-0980	Wrist strap cord, 1.5m (5 ft)
9300-0985	Wrist strap (large)
9300-0986	Wrist strap (small)
9300-1169	ESD heel strap (reusable 6 to 12 months)
9300-0793	Shoe ground strap (one-time use only)

Table 1. Static-Safe Accessories (continued)

HP Part Number	Description
<p>Note: The following ESD accessories can be ordered only from: Hewlett-Packard Company Computer Supplies Operation 1320 Kifer Road Sunnyvale, CA 94086 Phone: (408) 738-8858</p>	
92175A	Black, hard-surface, static control mat, 1.2m x 1.5m (4 ft x 5 ft)
92175B	Brown, soft-surface, static control mat, 2.4 m x 1.2 m (8 ft x 4 ft)
92175C	Small, black, hard-surface, static control mat, 1.2m x 0.9m (4 ft x 3 ft)
92175T	Tabletop static control mat, 58 cm x 76 cm (23 in x 30 in)
92176A	Anti-static carpet, natural color, 1.8m x 1.2m (6 ft x 4 ft)
92176B	Anti-static carpet, natural color, 2.4m x 1.2m (8 ft x 4 ft)
92176C	Anti-static carpet, russet color, 1.8 m x 1.2m (6 ft x 4 ft)
92176D	Anti-static carpet, russet color, 2.4m x 1.2m (8 ft x 4 ft)

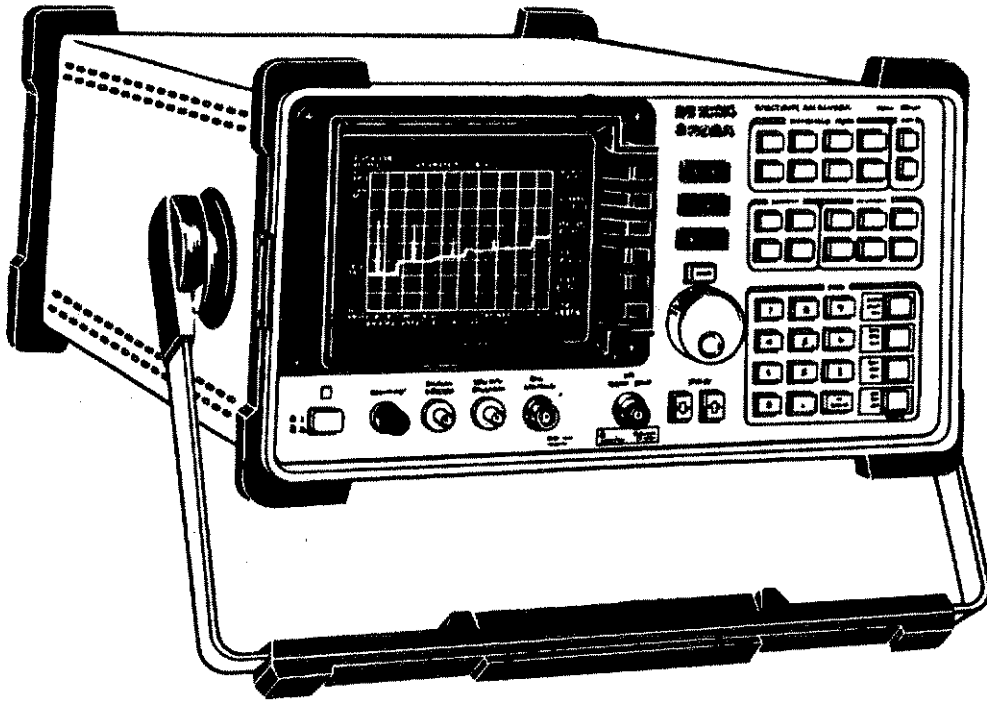

Figure 1-1. The HP 8592A Spectrum Analyzer

Options and Accessories Available

Options

Many options are available to tailor the analyzer to your needs. Options can be ordered by option number when you order the analyzer. Some of the options are also available as kits that can be ordered and installed after you have received your analyzer.

HP-IB (Option 021): Option 021 enables you to control your analyzer from a computer that uses an HP-IB interface bus. Such computers include the HP 200 and HP 300 series and the HP Vectra PC. The option also enables the analyzer to control a printer or plotter. Option 021 includes an HP-IB connector on the rear panel and an HP-IB Programming Manual.

Option 021 is also available as a kit (HP Part Number 08590-60052). The kit includes a printed circuit board, connector, manual, and installation instructions.

HP-IL (Option 022): Option 022 enables you to control your analyzer from a computer that uses an HP-IL interface bus. Such computers include the HP-71 and the HP-75. The option also enables the analyzer to control a printer or plotter. Option 022 includes an HP-IL connector on the rear panel and an HP-IL Programming Manual.

Option 022 is also available as a kit (HP Part Number 08590-60053). The kit includes a printed circuit board, connector, manual, and installation instructions.

RS-232 (Option 023): Option 023 enables you to control your analyzer from a computer that uses an RS-232 interface bus. Such computers include the HP Vectra PC, the IBM PC, XT, and AT, and compatibles. The option also enables the analyzer to control a printer or plotter. Option 023 includes an RS-232 connector on the rear panel and an RS-232 Programming Manual.

Option 023 is also available as a kit (HP Part Number 08590-60054). The kit includes a printed circuit board, connector, manual, and installation instructions.

Front-Panel Cover (Option 040): The front-panel cover snaps onto the front of your analyzer to protect the front panel during travel and when the unit is not in use. The cover has a recessed area in which you can store the Operating Manual, a programming manual, or an HP-71 Handheld Computer.

Option 040 is also available as a kit (Impact Cover Assembly, Deep; HP Part Number 5062-0792).

Rack Mount Flange Kit (Option 908): This option provides the parts necessary to mount the analyzer in an HP System II cabinet or in a standard 19-inch (482.6-mm) equipment rack.

Option 908 is also available as a kit (HP Part Number 5062-0800).

Rack Mount Flange Kit With Handles (Option 909): Option 909 is the same as option 908 but includes front handles for added convenience.

Option 909 is also available as a kit (HP Part Number 5062-1900).

Operating and Installation Manuals (Option 910): An additional copy of the Operating Manual and the Installation Manual are available as a set under Option 910. This set is called the Documentation Package, and has HP Part Number 08592-90001.

Service Documentation (Option 915): Option 915 includes one copy of the Operating Manual, the Installation Manual, and the Support Manual. This set is called the Support Package and has HP Part Number 08592-90007.

Accessories

A number of accessories are available from Hewlett-Packard to help you configure your analyzer for your specific needs.

CAUTION

Do not use dc-coupled probes; they may cause damage to the analyzer input circuit.

Broadband Preamplifier: The HP 8447D Preamp provides a minimum of 26 dB gain from 100 kHz to 1300 MHz to enhance measurements of very low-level signals.

Close Field Probe: The HP 11940A/11941A Close-Field Probes are small, hand-held, electromagnetic-field sensors. The probes provide repeatable, absolute, magnetic-field measurements from 30 MHz to 1 GHz with the 11940A, and from 9 kHz to 30 MHz with the 11941A. When attached to a source, the probes generate a localized magnetic field for electromagnetic interference (EMI) susceptibility testing.

Computer: The HP-71 Handheld Computer is a powerful, readily portable computational tool well suited to test instrument control. It uses a powerful BASIC language that allows structured programming techniques. It can be used to control the analyzer through the HP-IL interface (Option 022).

Monitor: The HP 82913A is a 12-inch monitor that provides a larger display for the analyzer in fixed installations.

Plotter: The HP ColorPro 7440A Graphics Plotter adds a color printout capability to the analyzer for permanent records of important measurements. The eight-pen HP ColorPro Plotter produces color plots with 0.025-mm (0.001-in.) resolution on either 8.5 x 11-inch paper or transparency film. The plotter can be ordered with HP-IB or RS-232 interfaces to correspond to the interface option installed on the analyzer.

Printer: The HP 2225A ThinkJet Personal Printer provides fast, quiet, portable printing with graphics capability for another form of permanent records of your test results. The printer can be ordered with HP-IB, HP-IL, or RS-232 interfaces to correspond to the interface option installed on the analyzer.

Rack Slide Kit: This kit (HP Part Number 1494-0060) provides the hardware to adapt Rack Mount Kits (Options 908 and 909) for mounting the analyzer on slides in an HP System II cabinet.

RF Limiter: The HP 11867A Limiter protects the analyzer input circuits from damage due to high power levels. It operates over a frequency range of dc to 1800 MHz and begins reflecting signal levels over 1 milliwatt up to 10 watts average power and 100 watts peak power.

Transit Case: The transit case (HP Part Number 9211-5604) provides extra protection for your analyzer for frequent travel situations. The HP transit case protects your instrument from hostile environments, shock, vibration, moisture, and impact while providing a secure enclosure for shipping.

50-ohm/75-ohm Minimum-Loss Pad: The HP 11852B is a low VSWR minimum-loss pad that is required for measurements on 75-ohm devices. It is effective over a frequency range of DC to 2 GHz.

75-ohm Matching Transformer: The HP 11694A allows you to make measurements in 75-ohm systems while retaining amplitude calibration. It is effective over a frequency range of 3 to 500 MHz.

Analyzers Covered By This Manual

This manual applies to analyzers with the serial number prefixes listed under SERIAL NUMBERS on the title page.

Serial Numbers

Hewlett-Packard makes frequent improvements to its products to enhance their performance, usability, or reliability, and to control costs. HP service personnel have access to complete records of design changes to each type of equipment, based on the equipment's serial number. Whenever you contact HP about your analyzer, have the complete serial number available to ensure obtaining the most complete and accurate information possible.

A mylar serial number label is attached to the rear of the analyzer. The serial number has two parts: the prefix (the first four numbers and a letter), and the suffix (the last five numbers). See Figure 1-2.

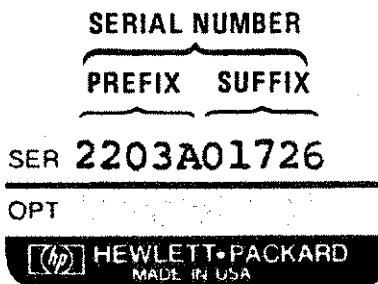

Figure 1-2. Typical Serial Number Label

The first four numbers of the prefix are a code that identifies the date of the last major design change that is incorporated in your analyzer. The letter identifies the country in which the unit was manufactured. The five-digit suffix is a sequential number and is different for each unit. Whenever you list the serial number or refer to it in obtaining information about your analyzer, be sure to use the complete number, including the full prefix and the suffix.

Specifications and Characteristics

Specifications describe the warranted analyzer performance over the temperature range of 0° to +55°C, unless otherwise stated. All specifications apply after the unit has reached a stable operating temperature as defined by the Temperature Stability Specification, and when functions are coupled (*AUTO COUPLE* key), and after calibration routines have been run, if required.

Characteristics provide useful information in the form of typical, nominal, or approximate values for analyzer performance.

Specifications

The analyzer specifications are listed in Table 1-1. Specifications apply in single frequency bands, and are typical for multiple bands.

Table 1-1. Analyzer Specifications

General Specifications
Temperature Range Operating 0 degrees to +55 degrees Celsius Storage —40 degrees to +75 degrees Celsius Temperature Stability The analyzer will meet its specifications 2 hours after storage at a constant temperature within the operating temperature range and 30 minutes after the analyzer is turned on
EMI Compatibility Conducted and radiated interference is in compliance with CISPR Publication 11 (1985) and Messemmpfaenger Postverfuegung 526/527/79 (Kennzeichnung Mit F-Nummer/Funkschutzzeichen)
Humidity Range Type-tested from 50% to 95% relative humidity ($\leq +40^{\circ}$ C) per requirements of MIL-STD-810C, Method 507.1, Procedure IV
Audible Noise < 37.5 dBA pressure and < 5.0 Bels power (ISO DP7779)
Power Requirements 86 to 127, or 195 to 253 volts rms; 47 to 66 Hz Power consumption is less than 160 VA

Table 1-1. Analyzer Specifications (continued)

Frequency Specifications
Frequency Range is covered in the following bands: 3 GHz to 22 GHz 50 kHz to 2.9 GHz 2.75 GHz to 6.2 GHz 6.0 GHz to 12.8 GHz 12.4 GHz to 19.4 GHz 19.1 GHz to 22 GHz
Frequency Accuracy Readout Accuracy (Tuning Accuracy) ± (2% of frequency span + 5 MHz), from 50 kHz to 2.75 GHz ± (2% of frequency span + 0.2% of center frequency), from 2.75 GHz to 22 GHz Resolution 4 digits
Frequency Spans Full Span with 4-digit resolution 0 GHz to 2.9 GHz 2.75 GHz to 22 GHz Zero Span Analyzer functions as a manually tuned receiver, at the frequency indicated by the CENTER FREQUENCY readout, for time domain display of signal modulation Frequency Span Readout Accuracy < ± 2% of indicated frequency span > 17 MHz < ± 5% of indicated frequency span ≤ 17 MHz
Frequency Sweep Automatic (AUTO) Sweep times from 20 milliseconds to 100 seconds, adjusted automatically to maintain absolute amplitude calibration for any combination of frequency span, resolution bandwidth, and video filter bandwidth Readout Accuracy < ± 10% of indicated sweep time setting

Table 1-1. Analyzer Specifications (continued)

Amplitude Specifications
Resolution and Stability
Noise Sidebands < $(-95 + 20 \text{ Log}N)$ dBc/Hz > 30 kHz offset from CW signal with 1-kHz resolution bandwidth and 30-Hz video bandwidth
Amplitude Range
—109 dBm to + 30 dBm for 50-ohm calibration
Maximum Safe Input Levels
Average Continuous Power +30 dBm (1 watt, 7.1 Vrms)
DC 0 volts
Peak Pulse Power +50 dBm (100 Watts) for < 10 usec pulse width and < 1% duty cycle. Input atten \geq 30 dB
Displayed Average Noise Level
< —90 dBm — 0.00038% of center frequency 50 KHz to 5 MHz
< —109 dBm for frequencies 5 MHz to 2.9 GHz
< —105 dBm for frequencies 2.75 GHz to 6.2 GHz
< —99 dBm for frequencies 6.0 GHz to 12.8 GHz
< —92 dBm for frequencies 12.4 GHz to 19.4 GHz
< —87 dBm for frequencies 19.1 GHz to 22 GHz
The displayed average noise level determines sensitivity (minimum discernible signal). Signals at this input level peak approximately 3 dB above the displayed noise level. Maximum average noise level with 0-dB input attenuation, 1-kHz resolution bandwidth, and 30-Hz video bandwidth.
Calibrated Display Range
Log; from reference level
70 dB with 10 dB/div amplitude scale
1 to 20 dB/div amplitude scales in 1-dB steps
Linear
8 divisions with LINEAR amplitude scale
Maximum Dynamic Range
70 dB for on-screen viewing
70 dB for signal-to-distortion
95 dB for IF-compression-to-noise
Readout Resolution (with markers)
< 0.05 dB for log scales
< 0.05% of reference level for linear scales
Units in dBm, dBmV, dB μ V, volts, and watts

Table 1-1. Analyzer Specifications (continued)

Amplitude Specifications (continued)
<p>Amplitude Accuracy With AUTO selected, amplitude accuracy is determined by one or more of the following factors and the signal-to-noise ratio.</p> <p>Calibrator Output (CAL OUTPUT) 299.9 MHz \pm 300 kHz -20 dBm \pm 1 dB level</p> <p>Reference Level 10-dB steps for calibrated reference level adjustment from -139 dBm to +50 dBm</p> <p>Reference Level Step Accuracy at Calibration Frequency (in corrected mode) Note: Before trying to verify these reference level step accuracies, you must run the Amplitude Calibration (<i>AMPTD CAL</i>) routine. < \pm 1.5 dB for +30 to -120 dBm range (0 to 60-dB attenuation) < \pm 1.0 dB for 0 to -120 dBm range (10-dB attenuation) at any fixed frequency < \pm 0.5 dB for 0 to -59 dBm range (10-dB attenuation) at any fixed frequency</p> <p>Frequency Response (with 10 dB attenuation and Preselector peaked) Note: Frequency response may include input attenuator and mixer flatness</p> <p>Reference to Calibrator OUTPUT (-20 dB \pm 1dB) < \pm 2.0 dB for frequencies 50 kHz to 2.9 GHz < \pm 2.0 dB for frequencies 2.75 GHz to 6.2 GHz < \pm 3.5 dB for frequencies 6.0 GHz to 12.8 GHz < \pm 4.0 dB for frequencies 12.4 GHz to 19.4 GHz < \pm 5.0 dB for frequencies 19.1 GHz to 22 GHz</p> <p>Input Attenuator 0 dB to 70 dB of input attenuation, selectable in 10-dB steps</p> <p>Input Attenuator Step Accuracy < \pm 0.5 dB; 0 dB to 60 dB range at 300 MHz < \pm 0.75 dB; 0 dB to 70 dB range at 300 MHz</p> <p>Resolution Bandwidth Switching (Amplitude Variation) < \pm 0.25 dB for 3 kHz to 3 MHz range</p> <p>Display Scale Fidelity CRT linearity and log fidelity affect amplitude accuracy at levels other than reference level</p> <p>Log Incremental Accuracy < \pm 0.1 dB/dB change over 70 dB-range</p> <p>Log Maximum Cumulative Error \pm 0.75 dB maximum over -60-dB range from reference level \pm 1.0 dB maximum over -70-dB range from reference level</p> <p>Linear Accuracy < \pm 3% of reference level setting</p> <p>Gain Compression Input < 0.5 dB for \leq -4 dBm total power at input mixer</p> <p>Image, Multiple, and Out-of-Band Responses < -70 dBc for frequencies < 18 GHz < -60 dBc for frequencies < 22 GHz</p> <p>Comb Generator Frequency Accuracy \pm 0.007%</p>

Characteristics

The analyzer characteristics are listed in Table 1-2.

Table 1-2. Analyzer Characteristics

Spectral Resolution and Stability
<p>Resolution Bandwidths 1 kHz to 3 MHz, eight selectable resolution bandwidths in 1,3,10 sequence. Bandwidth shape is approximately Gaussian (synchronously tuned, 4 pole filter). Bandwidth may be selected independently or coupled for optimum ratio of frequency span to resolution bandwidth.</p>
<p>Video Bandwidths 30 Hz to 3 MHz in 1,3,10 sequence. Post-detection low-pass filter averages displayed noise for a smooth trace. Video bandwidth may be selected independently or coupled for optimum ratio of frequency span to resolution and video bandwidth.</p>
<p>Drift <60 * N kHz/5 minutes; after 2 hour warm-up, and 5 minutes after setting center frequency</p>
<p>Signal Track Signal is held at display center, compensates for drift.</p>
Sweep Trigger
<p>Free Run End of each sweep triggers new sweep.</p>
<p>Line Sweep triggered at ac line (main) frequency.</p>
<p>Video Sweep triggered on post-detection video waveform. One-half major division of vertical deflection required to trigger sweep. Trigger level can be set by display line when video trigger is selected.</p>
<p>Single Single sweep started or reset by pressing <i>TRIG</i>, [SINGLE SWEEP].</p>
<p>External BNC input (rear panel), TTL levels, positive edge triggers sweep.</p>

Table 1-2. Analyzer Characteristics (continued)

Amplitude Accuracy				
Log Scale Switching No significant error for 1- to 20-dB/div scale range. Scale switching is a built-in function of the product design.				
Input Attenuator Step Accuracy				
<u>ATTEN (dB)</u>	<u>FREQUENCY (GHz)</u>			
	<u>50 kHz - 2.9</u>	<u>2.9 - 12.4</u>	<u>12.4 - 19</u>	<u>19 - 22</u>
0	±1.00 dB	±1.40 dB	±1.50 dB	±2.10 dB
10	±0.00 dB	±0.00 dB	±0.00 dB	±0.00 dB
20	±1.10 dB	±1.50 dB	±1.50 dB	±2.20 dB
30	±1.20 dB	±1.60 dB	±1.70 dB	±2.30 dB
40	±1.30 dB	±1.70 dB	±1.80 dB	±2.70 dB
50	±1.40 dB	±1.90 dB	±2.10 dB	±3.00 dB
60	±1.60 dB	±2.10 dB	±2.40 dB	±3.50 dB
70	±1.70 dB	±2.50 dB	±2.70 dB	±3.90 dB
Peak Variation < ± 0.5 dB 50 kHz - 2.9 GHz < ± 1.0 dB 2.75 GHz - 22GHz				
Front Panel Inputs/Outputs				
INPUT 50 OHM Input Impedance 50 ohms nominal; BNC female connector.				
1ST LO OUTPUT 3.0 to 6.6 GHz, —5.6 dBm nominal, 50-ohm SMA connector.				
CAL OUTPUT —20 dBm at 299.9 MHz, with second through fourth harmonics greater than —60 dBm into 50 ohms.				
100 MHz COMB OUT 50-ohm SMA, 100 MHz ± 0.007%				
Rear-Panel Inputs/Outputs				
AUX VIDEO OUTPUT 50-ohm BNC connector, 0 to 1 volt.				
MONITOR OUTPUT 50-ohm BNC connector, NTSC format, 19.2 kHz horizontal sync.				
HIGH SWEEP IN/OUT BNC connector, TTL high = sweep, TTL low = retrace.				
SWEEP OUTPUT BNC connector, 10k ohm, 0 to +10-volt ramp.				
AUX IF OUTPUT 50-ohm BNC connector, —10 to —60 dBm signal level, 21.4 MHz.				

Table 1-2. Analyzer Characteristics (continued)

<p>EXTERNAL TRIGGER INPUT BNC connector, TTL levels, positive edge triggers sweep.</p> <p>Interface Connector HP-IB (Option 021), HP-IL (Option 022), or RS-232 (Option 023)</p> <p>HP-IB Codes SH1, AH1, T6, L4, SR1, RL1, PP0, DC1, C1, C2, C3, and C28</p>	
<p>Weight</p>	
<p>Net 15 kg (33 lbs)</p>	
<p>Shipping 15.8 kg (34.8 lbs)</p>	
<p>Dimensions</p>	
<p>Legend: inches (millimeters)</p>	<p>The technical drawings show the following dimensions:</p> <ul style="list-style-type: none"> TOP View: Overall height is $14\frac{1}{8}$ inches (373 mm). The height of the main body is $13\frac{1}{2}$ inches (337 mm). REAR View: The depth of the rear panel is 8 inches (200 mm). SIDE View: The overall width is $18\frac{1}{8}$ inches (460.5 mm). The height of the side panel is $7\frac{1}{2}$ inches (184 mm).

CHAPTER 2

PREPARATION FOR USE

What You'll Find in This Chapter

This chapter describes the process of getting the Spectrum Analyzer ready to use. The process includes initial inspection procedures, setting up the unit for the selected ac power source, and performing automatic calibration routines and a confidence test to indicate that the unit is operating correctly.

Getting Ready

Initial Inspection

Inspect the shipping container for damage. If the shipping container or cushioning material is damaged, keep it until you have verified that the contents are complete and you have tested the analyzer mechanically and electrically.

The contents of the shipment should be as shown in Figure 2-1 and its accompanying legend. If the contents are incomplete or if the analyzer does not pass the operation verification tests (procedures are provided in Chapter 3), notify the nearest Hewlett-Packard office. If the shipping container is damaged or the cushioning material shows signs of stress, also notify the carrier. Keep the shipping materials for the carrier's inspection. The HP office will arrange for repair or replacement without waiting for a claim settlement.

If the shipping materials are in good condition, retain them for possible future use. You may wish to ship the analyzer to another location or to return it to Hewlett-Packard for service. See "How to Return Your Analyzer for Servicing."

Preparing the Analyzer for Use

The analyzer is a portable instrument and requires no physical installation other than connection to a source of ac power.

CAUTION

DO NOT connect ac power until you have verified that the line voltage is correct, the proper fuse is installed, and the line voltage selector switch is properly positioned, as described in the following paragraphs. Damage to the equipment could result.

Note: Complete instructions for installing your analyzer in an equipment rack are provided in a Service Note that is included with Options 908 and 909 Rack Mounting Kits.

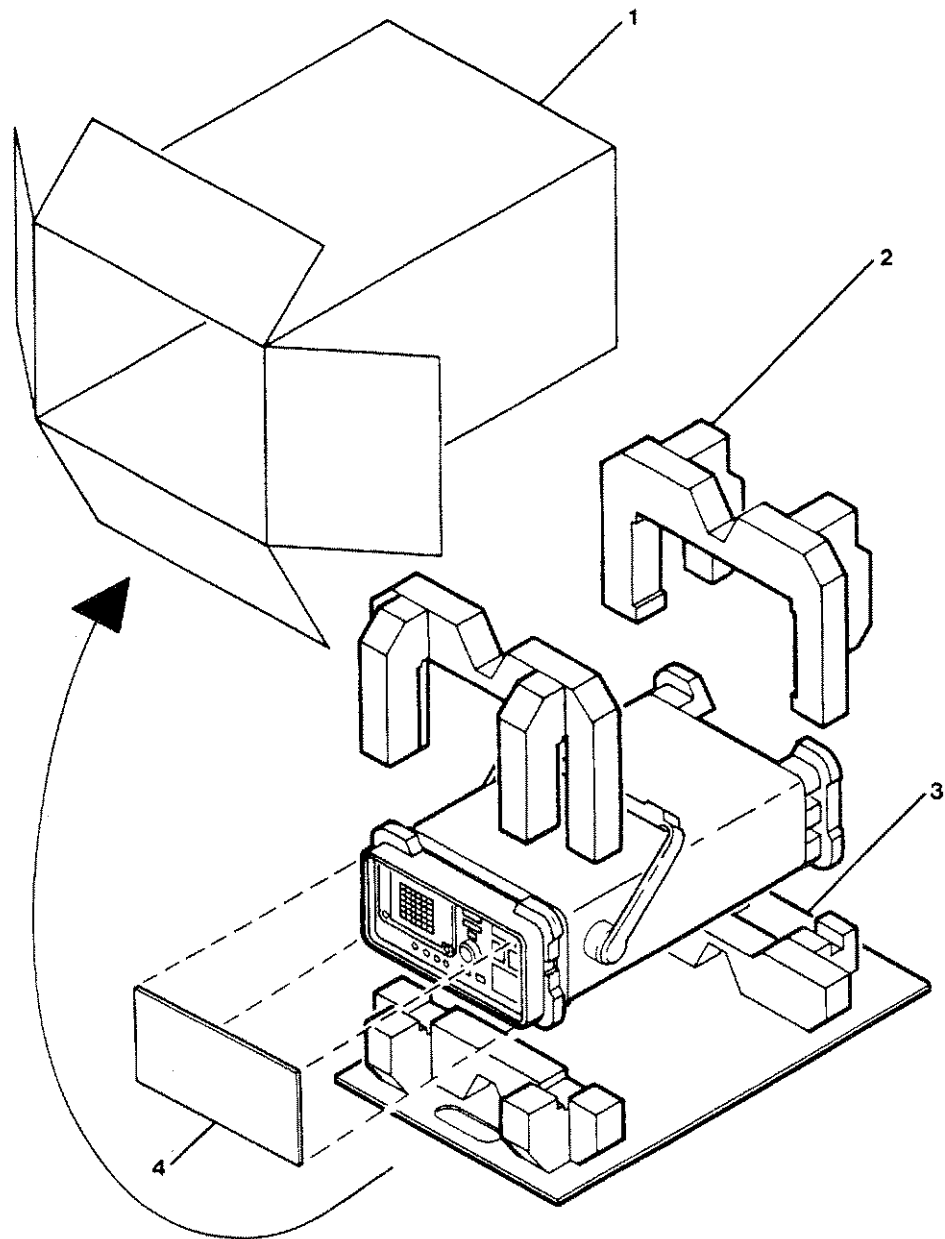

Legend for Figure 2-1:

Item	Description	HP Part Number
1	Outer Carton	9211-5636
2	Pads (2)	08592-80013
3	Bottom Tray	08592-80014
4	Front Pad	9220-4488

Figure 2-1. Analyzer Shipping Container and Contents

Setting the Line Voltage Selector Switch

CAUTION

BEFORE CONNECTING the analyzer to the power source, you must set the rear-panel voltage selector switch correctly to adapt the analyzer to the power source. An improper selector switch setting can damage the analyzer when it is turned on.

Set the instrument's rear-panel voltage selector switch to the line voltage range (115V or 230V) corresponding to the available ac voltage. See Figure 2-2. Insert a small screwdriver or similar tool in the slot and slide the switch up or down so that the proper voltage label is visible.

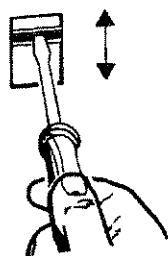

Figure 2-2. Setting the Voltage Selector Switch

Checking the Fuse

Note: The ac line input fuse is the same value regardless of the input line voltage. It is a fast-blow fuse, rated at 6.3A, 250V; its HP part number is 2100-0703.

The line fuse is housed in a small container immediately above the rear-panel power connector (see Figure 2-3). The container provides space for storing a spare fuse, as shown in the figure.

To check the fuse, insert the tip of a screwdriver in the slot at the bottom of the container and pry gently to remove the container. If the fuse is defective or missing, install a new fuse in the proper position and reinsert the fuse container.

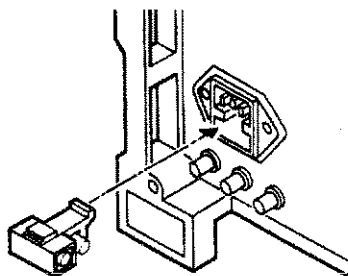

Figure 2-3. Checking the Line Fuse

Power Cable

The analyzer is equipped with a three-wire power cable, in accordance with international safety standards. When connected to an appropriate power line outlet, this cable grounds the instrument cabinet.

WARNING

Failure to ground the analyzer properly can result in personal injury. Before turning on the analyzer, you must connect its protective earth terminals to the protective conductor of the main power cable. Insert the main power cable plug only into a socket outlet that has a protective earth contact. DO NOT defeat the earth-grounding protection by using an extension cable, power cable, or autotransformer without a protective ground conductor. If you are using an autotransformer, make sure its common terminal is connected to the protective earth contact of the power source outlet socket.

Various power cables are available to connect the analyzer to the types of ac power outlets unique to specific geographic areas. The cable appropriate for the area to which the analyzer is originally shipped is included with the unit. You can order additional ac power cables for use in different areas. Table 2-2 lists the available ac power cables, illustrates the plug configurations, and identifies the geographic area in which each cable is appropriate.





Power Requirements

The power requirements for the analyzer are listed in Table 2-1.

Table 2-1 Power Requirements

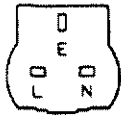
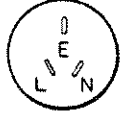
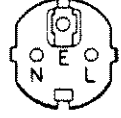
Characteristic	Requirement
Input Voltage	86 to 127, or 195 to 253 volts rms
Frequency	47 to 66 Hz
Power	160 VA max

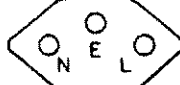
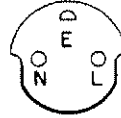
Table 2-2. AC Power Cables Available

Plug Type**	Cable HP Part Number	Plug Description	Cable Length cm (inches)	Cable Color	For Use In Country
250V 	8120-1351 8120-1703	Straight*BS1363A 90°	229 (90) 229 (90)	Mint Gray Mint Gray	Great Britain, Cyprus, Nigeria, Rhodesia, Singapore, So. Africa, India
250V 	8120-1369 8120-0696	Straight*NZSS198/ASC112 90°	201 (79) 221 (87)	Gray Gray	Australia, New Zealand
250V 	8120-1689 8120-1692	Straight*CEE7-Y11 90°	201 (79) 201 (79)	Mint Gray Mint Gray	East and West Europe, Saudi Arabia, United Arab Republic (unpolarized in many nations)
125V 	8120-1348 8120-1398 8120-1754	Straight*NEMA5-15P 90° Straight*NEMA5-15P	203 (80) 203 (80) 91 (36)	Black Black Black	United States Canada, Japan (100 or 200V), Mexico, Philippines, Taiwan
	8120-1378 8120-1521 8120-1676	Straight*NEMA5-15P 90° Straight*NEMA5-15P	203 (80) 203 (80) 91 (36)	Jade Gray Jade Gray Jade Gray	
250V 	8120-2104	Straight*SEV1011 1959-24507 Type 12	201 (79)	Gray	Switzerland
220V 	8120-0698	Straight*NEMA6-15P			
250V 	8120-1860	Straight*CEEE22-V1			
<p>* Part number shown for plug is industry identifier for plug only. Number shown for cable is HP Part Number for complete cable, including plug.</p> <p>** E = Earth Ground; L = Line; N = Neutral.</p>					

Turning the Analyzer On for the First Time

When you turn the analyzer on for the first time, you should perform frequency and amplitude calibration routines to calibrate and indicate that the unit is functioning correctly. These are automatic self-tests that are completed in less than 15 minutes and require no external test equipment.

Perform the following steps:

1. Press *LINE*.

After a few seconds, the screen displays the analyzer's model number (HP 8592A), and the firmware date (for example, 10.9.86 indicates September 10, 1986).

CAUTION

DO NOT exceed the maximum input power. The maximum input power is +30 dBm (1 watt) continuous; 0 volt dc.

Note: Record the firmware date and keep it for reference. If you should ever need to call HP for service or with any questions regarding your analyzer, it will be helpful to have the firmware date readily available.

If your analyzer is equipped with Option 021 (HP-IB interface) or Option 022 (HP-I interface), the appropriate interface address (HP-IB ADRS: XX or HP-IL ADRS: XX) also appears on the screen. If your analyzer is equipped with Option 023 (RS-232 interface), the baud rate (RS232: XXXX) is displayed.

2. Allow the analyzer to warm up in accordance with the Temperature Stability specification in Table 1-1.
3. Connect a 50-ohm coaxial cable, such as HP 10502A, and a BNC/type N to type N adapter between the front-panel CAL OUTPUT and the analyzer INPUT connectors.
4. Perform the frequency calibration routine by pressing *CAL* and [CAL FREQ].

CAUTION

Do not press [CAL FREQ] or [CAL AMPTD] when the CAL OUTPUT is not connected to the analyzer INPUT.

During the routine, CAL: SWEEP, CAL: FREQ, CAL: SPAN, CAL: SWEEP DELAY and CAL: 2nd LO are displayed as the sequence progresses. CAL: DONE appears when the routine is completed. Any failures or discrepancies produce a message on the screen; see Appendix A for descriptions of screen messages.

-
5. Perform the amplitude calibration routine by pressing [CAL AMPTD].

During the routine, CAL; AMPTD, CAL: 3 dB BW, CAL: ATTEN, and CAL: LOGAMP are displayed as the sequence progresses. CAL: DONE appears when the routine is completed. Any failures or discrepancies produce a message on the screen; see Appendix A.

6. When the frequency and amplitude calibration routines have been completed successfully, store the data by pressing [CAL STORE].

The calibration routines calibrate the analyzer by generating correction factors. [CAL STORE] stores the calibration correction factors in non-volatile memory; the analyzer will automatically apply these factors in future measurements.

CAUTION

Do not press [CAL STORE] if any of the calibration routines are not successfully completed per the above procedure. Press *CAL* and [CAL FETCH] to retrieve the previous calibration data if any of the calibration routines are interrupted such as by pressing *PRESET*. Press *PRESET*, *CAL* and [CAL FETCH] to retrieve the previous calibration data if [CAL FREQ] or [CAL AMPTD] is accidentally pressed when the CAL OUTPUT is not connected to the analyzer INPUT.

When the calibration routines have been completed successfully, the analyzer is ready for normal operation.



CHAPTER 3

VERIFYING SPECIFIED OPERATION

What You'll Find in This Chapter

This chapter contains five test procedures which test the electrical performance of the Spectrum Analyzer. Collectively, these tests are called Operation Verification.

What is Operation Verification?

Operation Verification verifies that performance is within the most critical specifications of Table 1-1. The following tests are included in Operation Verification:

- Calibrator Amplitude And Frequency Accuracy
- Displayed Average Noise
- Frequency Span Readout Accuracy
- Frequency Readout Accuracy
- Frequency Response Flatness

Operation Verification takes less than one hour. You can use Operation Verification as a quick incoming inspection test or as a partial calibration test. If the analyzer passes Operation Verification, there is an 80% confidence level that it meets all its specifications.

The highest level test, called a Performance Verification test, is an in-depth test that verifies that performance is within all specifications of Table 1-1. This test is time consuming and requires extensive test equipment. It is documented in the Support Manual; see "Service Documentation (Option 915)" in Chapter 1 for ordering information.

None of the test procedures described above involve removing the cover of the spectrum analyzer.

Before You Start Operation Verification

There are four things you must do **before** starting Operation Verification:

1. Switch the analyzer on and let it warm up in accordance with the Temperature Stability specification in Table 1-1.
2. Read Chapter 1 of the Operating Manual, "Making Your First Measurement."
3. After the analyzer has warmed up as specified, perform the Calibration Procedure documented in "Making Your First Measurement." The performance of the analyzer is only specified after the analyzer calibration routines have been run and if the analyzer is auto-coupled.
4. Read the rest of this section before you start any of the tests, and make a copy of the Operation Verification Test Record described below.

Test Equipment You'll Need

Table 3-1 lists the recommended test equipment for Operation Verification. Any equipment that meets the critical specifications given in the table can be substituted for the recommended model(s).

Accessories You Should Have

Table 3-2 lists a number of accessories used during Operation Verification.

Recording the Test Results

A small test results table is provided at the end of each test procedure for your convenience in recording test results as you perform the procedure.

In addition, a complete Operation Verification Test Record form is provided as Table 3-9 at the end of the chapter. We recommend that you make a copy of this table, record the complete test results on the copy, and keep the copy for your calibration test record. This record could prove valuable in tracking gradual changes in test results over long periods of time.

If the Analyzer Doesn't Meet Specifications

If the analyzer doesn't meet one or more of the specifications, complete any remaining Operation Verification tests and record all test results on a copy of the test record. Then refer to Chapter 4, "If Something Goes Wrong...", for instructions on how to solve the problem.

Periodically Verifying Operation

The analyzer requires periodic verification of operation. Under most conditions of use, you should test the analyzer at least once a year with either Operation Verification or the complete set of Performance Tests.

Table 3-1. Recommended Test Equipment

Instrument	Critical Specification	Recommended Model
Synthesizer/ Level Generator	Frequency accuracy: 1×10^{-9} /day Output flatness: ± 0.5 dB Frequency range: 200 Hz to 10 MHz	HP 3335A
Synthesized Sweeper	Frequency accuracy: 1×10^{-9} /day Output flatness: $< \pm 0.6$ dB Frequency range: 10 MHz to 26.5 GHz	HP 8340A*
Power Meter	Measure levels 0 to — 20 dBm Accuracy ± 0.5 %	HP 436A
Power Sensor	Frequency range: 100 kHz to 2 GHz Power range: 10 μ W to 1 mW	HP 8485A
Power Splitter	Equivalent output SWR: ≤ 1.10 (leveling) Frequency range: 10 MHz to 2 GHz Maximum input power: ≥ 10 dBm	HP 11667B
AM/FM Signal Generator	Frequency range: 500 kHz to >500 MHz AM modulation: > 20 Hz with external signal Pulse modulation: 500 Hz PRF, > 2 μ s pulse width Output flatness: ± 0.5 dB Spurious: ≤ 100 dBc	HP 8640B
50-ohm Load (BNC)	Not critical	HP 11593A
Frequency Counter	Frequency Range >300 MHz Amplitude —20 dBm (23.6 mV)	HP 5383A

*Notes: the following alternate models can be used in place of the HP 8340A, as indicated; however, range limitations in their critical specifications may prevent complete testing:

- (1) for Frequency Readout Accuracy Test: HP 8640B AM/FM Signal Generator with Option 002 Doubler; Frequency range: 500 kHz to 1024 MHz
- (2) for Frequency Response Flatness Test: HP 8350A/835-22A Sweep Oscillator; Output flatness: $< \pm 0.6$ dB
- (3) for both tests (1) and (2): HP 8642B Signal Generator; Frequency range: 100 kHz to 2115 MHz (Low Band only)

Table 3-2. Recommended Accessories

Accessory	Recommended HP Part Number
50- Ω Termination (BNC)	11593A
SMA (f) to SMA (f)	1250-1158
SMA (m) to BNC (f)	1250-1200
Type N (m) to BNC (f) (2 required)	1250-0780
Type N (m) to APC 3.5 (f)	1250-1744
BNC Cable (2 required)	8120-1839

Verification Tests

Calibrator Amplitude and Frequency Accuracy

This test measures the accuracy of the analyzer's calibrator signal. The analyzer uses this signal in its calibration routines. Therefore, the calibration of the analyzer depends on the accuracy of this signal. The calibrator signal is measured directly using a power meter for amplitude accuracy and a frequency counter for frequency accuracy.

Specification

Amplitude: $-20 \text{ dB} \pm 1.0 \text{ dB}$
Frequency: $299.9 \text{ MHz} \pm 300 \text{ kHz}$

Recommended Equipment

Frequency Counter. HP 5383A
Power Meter. HP 436A
Power Sensor. HP 8482A
BNC cable. HP Part Number 8120-1839

Test Procedure

1. Press *PRESET* on the analyzer.
2. Calibrate the power meter and power sensor.
3. Connect the power sensor to the CAL OUTPUT of the analyzer.
4. Record the power reading on a copy of the test record. The power reading should be between the values shown on the test record.

5. Set the frequency counter input impedance to 50 ohms and the gate time to MHz.
6. Connect the analyzer's CAL OUTPUT to the input of the frequency counter.
7. Record the frequency reading of the counter on copies of Table 3-3, Calibrator Amplitude and Frequency Accuracy, and Table 3-9, Operation Verification Test Record. The frequency reading should be between the values shown on the tables.

Test Results

Table 3-3. Calibrator Amplitude and Frequency Accuracy

Test Description	Results		
	Minimum	Actual	Maximum
Calibrator Amplitude 50 Ohms:—20 dBm	—21 dBm	_____	—19 dBm
Frequency Accuracy 299.9 MHz	299.6 MHz	_____	300.2 MHz

Displayed Average Noise

This test measures the noise generated by the circuits of the analyzer. This noise, called average noise, affects the analyzer's ability to measure small signals. The lower the average noise level, the greater the sensitivity and dynamic range.

This test uses the marker to measure the displayed noise with no input signal present. Since the noise measured by this test is internal to the analyzer, it is not affected by the input attenuator. However, the input attenuator setting is coupled to the displayed amplitude level. Therefore, the input attenuator must be set to 0 dB to get an accurate amplitude reading of the noise.

Specification

Maximum average noise level with 0-dB in/out attenuation, 1-kHz resolution bandwidth, and 30-Hz video bandwidth:

<-90 dBm - (0.00038% of CF)	50 kHz-5 MHz
<-109 dBm	5 MHz-2.9 GHz
<-105 dBm	2.75-6.2 GHz
<-99 dBm	6.0-12.8 GHz
<-92 dBm	12.4-19.4 GHz
<-87 dBm	19.1-22 GHz

Recommended Equipment

50 Ohm Termination (BNC)..... HP 11593A

Test Procedure

1. Connect the 50 ohm termination to the analyzer INPUT of the analyzer.

50 kHz to 5 MHz <-90 dBm —(0.00038% of CF)
5 MHz to 2.9 GHz <-109 dBm

2. Press the following analyzer keys:
PRESET (wait until the preset is complete)
SPAN 0 HZ
SWP BW [RES BW] 1 kHz
[VID BW] 3 0 Hz
AMPLITUDE 8 0 —dBm
ATTEN 0 dB
FREQUENCY 4 0 0 kHz

-
3. Press the following analyzer keys:
TRIG [SINGLE SWEEP]
MKR
PEAK SEARCH
 4. Read the average noise level as the marker amplitude.
 5. Repeat steps 3 and 4 for the analyzer frequencies (10 MHz, 1450 MHz and 2900 MHz) shown in Table 3-4.
 6. Record the test results in Table 3-4, Displayed Average Noise, and in Table 3-9, Operation Verification Test Record.

2.75 to 6.2 GHz <—105 dBm

7. Press the following analyzer keys:
PRESET
[HRM LOCK] [2.75-6.2 BAND 1]
SPAN 0 HZ
SWP/BW [RES BW] *1 kHz*
[VID BW] *3 0 Hz*
AMPLITUDE 8 0 —dBm
[ATTEN] *0 dB*
FREQUENCY 2 7 0 0 MHz
8. Press the following analyzer keys:
TRIG [SINGLE SWEEP]
MKR
PEAK SEARCH
9. Read the average noise as the marker amplitude.
10. Repeat steps 8 and 9 for frequencies 4500 and 6200 MHz.
11. Record the test results in Table 3-4, Displayed Average Noise, and in Table 3-9, Operation Verification Test Record.

6.0 to 12.8 GHz —99 dBm

12. Press the following analyzer keys:
PRESET
[HRM LOCK] [6.0-12.8 BAND 2]
SPAN 0 HZ
SWP/BW [RES BW] *1 kHz*
[VID BW] *3 0 Hz*
AMPLITUDE 8 0 —dBm
[ATTEN] *0 dB*
FREQUENCY 6 0 0 0 MHz

-
13. Press the following analyzer keys:

TRIG [SINGLE SWEEP]

MKR

PEAK SEARCH

14. Read the average noise as the marker amplitude.

15. Repeat steps 12 through 14 for frequencies 9250 MHz and 12800 MHz.

16. Record the test results in Table 3-4, Displayed Average Noise, and in Table 3-9, Operation Verification Test Record.

12.4 to 19.4 GHz <—92 dBm

17. Press the following analyzer keys:

PRESET

[HRM LOCK] [12.4-22 BAND 3]

SPAN 0 HZ

SWP/BW [RES BW] 1 kHz

[VID BW] 3 0 Hz

AMPLITUDE 7 0 —dBm

[ATTEN] 0 dB

FREQUENCY 1 2 4 0 0 MHz

18. Press the following analyzer keys:

TRIG [SINGLE SWEEP]

MKR

PEAK SEARCH

19. Read the average noise as the marker amplitude.

20. Repeat steps 17 through 19 for frequencies of 18500 and 19400.

21. Record the test results in Table 3-4, Displayed Average Noise, and in Table 3-9, Operation Verification Test Record.

19.1 to 22 GHz <—87 dBm

22. Repeat steps 17 through 19 for frequencies of 19.1 and 22 GHz in Band 4.

23. Record the test results in Table 3-4, Displayed Average Noise, and in Table 3-9, Operation Verification Test Record.

Table 3-4. Displayed Average Noise

Test Description	Results		
	Minimum	Actual	Maximum
Displayed Average Noise			
400 kHz		_____	-88.48 dBm
10 MHz		_____	-109 dBm
1450 MHz		_____	-109 dBm
2900 MHz		_____	-109 dBm
2700 MHz		_____	-105 dBm
4500 MHz		_____	-105 dBm
6200 MHz		_____	-105 dBm
6000 MHz		_____	-99 dBm
9250 MHz		_____	-99 dBm
12800 MHz		_____	-99 dBm
12400 MHz		_____	-92 dBm
18500 MHz		_____	-92 dBm
19400 MHz		_____	-92 dBm
19100 MHz		_____	-87 dBm
22000 MHz		_____	-87 dBm

Frequency Span Readout Accuracy

This test measures the analyzer's ability to accurately read the frequency of two signals at the same time.

The analyzer's internal 100 MHz comb generator is used to test the wide spans (100 MHz to 2000 MHz). A signal generator is modulated with a synthesizer to generate comb signals for testing the narrow spans (50 kHz to 1 MHz).

Recommended Equipment

AM/FM Signal Generator.	HP 8640B
Frequency Synthesizer.	HP 3335A
BNC cable (2 required).	HP Part Number 8120-1839
Adapter, Type N (m) to BNC (f).	HP Part Number 1250-0780
SMA cable (1 required).	HP Part Number 8120-1578
	(f → f) 1250-1158 or (m → f) 1250-1200

Test Procedure (100 MHz TO 22 GHz spans)

1. Connect the analyzer 100 MHz Comb Generator to the INPUT 50 Ohm connector of the analyzer.
2. Press the following analyzer keys:
PRESET (wait until the preset is complete)
AMPLITUDE
DOWN ARROW DOWN ARROW
SPAN 1 0 0 MHz
If necessary press *FREQUENCY* and use the RPG to place the comb teeth at the left and right edges of the CRT graticule.
3. Press *MKR* and turn the RPG to place the marker at the peak of either the left or right comb tooth.
4. Press [MARKER DELTA] and place the second marker at the peak of the other comb tooth.
5. Read the span as the marker delta frequency. Record the span on copies of Table 3-5, Frequency Span Readout Accuracy, and Table 3-9, Operation Verification Test Record. The span should be between the values shown in the tables (98 MHz and 102 MHz).
6. Repeat steps 3 through 5 for the remaining frequency spans (500, 1000, and 2000 MHz).

NOTE: It is not necessary to check the frequency span in the other bands as the span dividers are fully checked in Band 0 (50 kHz to 2.9 GHz).

Test Procedure (50 kHz to 1 MHz spans)

1. Connect the equipment as shown in Figure 3-1.
2. Set the HP 8640B Signal Generator for —10 dBm, 10 MHz, and its amplitude modulation input for ac coupling.
3. Set the HP 3335A Frequency Synthesizer to +10 dBm at 100 kHz and adjust the signal generator for 90% amplitude modulation.
4. Press the following analyzer keys:

PRESET (wait until the preset is complete)

FREQUENCY 1 0 MHz

SPAN 1 MHz

PEAK SEARCH SIGNAL TRACK MKR [MARKER NORMAL]

Use the knob to set the marker on the peak of the signal at the left edge of the screen.
[MARKER DELTA]

Use the knob to set the second marker on the peak of the signal at the right edge of the screen.

5. Read the span as the marker delta frequency. Record the span on the copies of Tables 3-5 and 3-9. The span should fall between the values shown on the tables (800 kHz \pm 40 kHz).
6. Repeat step 4 for a span of 500 kHz with the frequency synthesizer set to 100 kHz. Record the span (marker reading) (400 kHz \pm 20 kHz) on the copies of Tables 3-5 and 3-9.
7. Use the following settings to test the analyzer's 50- and 100-kHz spans. Record the results.

Analyzer Span	HP 3335A Frequency
50 kHz	5 kHz
100 kHz	10 kHz

TRACE A [VIEW A] MKR [MARKER NORMAL]

Use the knob to set the marker on the peak of the signal at the left side of the screen.
[MARKER DELTA]

Use the knob to set the marker on the peak of the signal at the right side of the screen.

Test Results

Table 3-5. Frequency Span Readout Accuracy

Test Description	Results		
	Minimum	Actual	Maximum
Frequency Span Readout Accuracy			
50 kHz	38.00 kHz	_____	42.00 kHz
100 kHz	76.00 kHz	_____	84.00 kHz
500 kHz	380.00 kHz	_____	420.00 kHz
1 MHz	760.00 kHz	_____	840.00 kHz
100 MHz	98.00 MHz	_____	102.00 MHz
500 MHz	392.00 MHz	_____	408.00 MHz
1000 MHz	882.00 MHz	_____	918.00 MHz
2000 MHz	1862.00 MHz	_____	1938.00 MHz

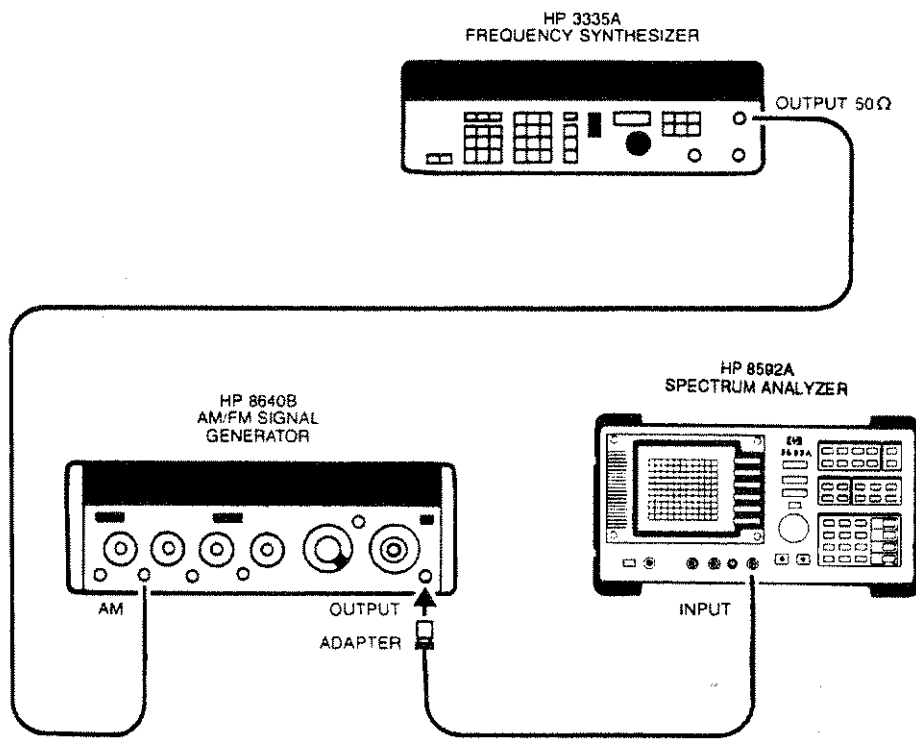

50-kHz to 1-MHz Spans

Figure 3-1. Test Setup—Frequency Span Readout Accuracy

Frequency Readout Accuracy

This test verifies the analyzer's ability to measure the frequency of a single CW signal. The test requires a synthesized frequency source that has better frequency accuracy than the analyzer. Note that two different Hewlett-Packard synthesized sources are recommended to cover the specified frequency range of the analyzer.

Specification

$\pm(5 \text{ MHz}+2\% \text{ Span})$	50 kHz to <2.75 GHz
$\pm(0.2\% \text{ CF}+2\% \text{ Span})$	2.75 to 22 GHz

Recommended Equipment

Frequency Synthesizer.	HP 3335A
Synthesized Sweeper.	HP 8340A
BNC cable.	HP Part Number 8120-1839
SMA cable.	HP Part Number 8120-1578

Output adapters for HP 8340:

SMA(f) to SMA(f).	HP Part Number 1250-1158
SMA(m) to BNC(f).	HP Part Number 1250-1200

Test Procedure

1. Connect the 50 Ω OUTPUT of the HP 3335A Frequency Synthesizer to the RF INPUT of the analyzer with a BNC cable.
2. Set the frequency synthesizer output to 1 MHz and -20 dBm with no modulation.
3. Press the following analyzer keys:
PRESET (wait until the preset is complete)
SPAN 2 0 MHz
FREQUENCY 1 MHz
PEAK SEARCH [NEXT PEAK RIGHT]
SIGNAL TRACK
SPAN 1 0 MHz
4. Record the analyzer's frequency reading in Table 3-7, Frequency Readout Accuracy Test Results, and in Table 3-9, Operation Verification Test Record.
5. Repeat steps 2, 3, and 4 for the frequencies shown in Table 3-7, Frequency Readout Accuracy; use an HP 8340A/B Synthesized Sweeper instead of the HP 3335A Frequency Synthesizer for the frequencies above 4 MHz.

6. Frequency readout accuracy in harmonic bands is checked at frequencies shown in Table 3-6.

Table 3-6. Frequency readout accuracy in harmonic bands

Harmonic Band	Frequency Checked
2.75-6.2 GHz	4.0 GHz
6.0-12.8 GHz	9.0 GHz
12.4-19.4 GHz	16.0 GHz
19.1-22 GHz	20.0 GHz

7. Record the analyzer's marker frequency readout in Table 3-7, Frequency Readout Accuracy, and Table 3-9, Operation Verification Test Record.

Table 3-7. Frequency Readout Accuracy

Test Description	Results		
	Minimum	Actual	Maximum
Frequency Readout Accuracy			
1 MHz	0.0 MHz	_____	2.01 MHz
4 MHz	0.0 MHz	_____	8.01 MHz
50 MHz	44.80 MHz	_____	55.20 MHz
100 MHz	94.80 MHz	_____	105.20 MHz
500 MHz	494.80 MHz	_____	505.20 MHz
1000 MHz	994.80 MHz	_____	1005.20 MHz
2000 MHz	1994.80 MHz	_____	2005.20 MHz
4000 MHz	3991.80 MHz	_____	4008.20 MHz
9000 MHz	8981.80 MHz	_____	9018.20 MHz
16000 MHz	15967.80 MHz	_____	16032.20 MHz
20000 MHz	19959.80 MHz	_____	20040.20 MHz

VERIFICATION

Frequency Response Flatness

This test measures the analyzer's ability to accurately compare the amplitudes of two signals of equal amplitude but different frequency (e.g., a two-tone intermodulation measurement). This ability, called flatness, affects the analyzer's ability to accurately compare the amplitudes of two signals of unequal amplitude (e.g., carriers and sidebands).

A synthesized sweeper is used for this test because its flatness is relatively better than the analyzer's. The sweeper tunes a signal through the band of the analyzer while the analyzer is in [MAX HOLD A]. This procedure traces the flatness of the analyzer on the analyzer's screen. Two different synthesized sweepers are used to cover the entire frequency range of the analyzer.

Specification (with 10-dB Attenuation and preselector peaked). Referenced to Calibrator at -20-dB and 299.9 MHz; (includes bandswitching uncertainty).

50 kHz to 2.9 GHz	± 2.0 dB
2.75 GHz to 6.2 GHz	± 2.0 dB
6.0 GHz to 12.8 GHz	± 3.5 dB
12.4 GHz to 19.4 GHz	± 4.0 dB
19.1 GHz to 22 GHz	± 5.0 dB

Recommended Equipment

Frequency Synthesizer.	HP 3335A
Synthesized Sweeper.	HP 8340A
Power Meter.	HP 436A
Power Sensor.	HP 8485A
Power Splitter.	HP 11667B
SMA Cable (3 required).	HP 8120-1578
BNC Cable.	HP 8120-1839

Adapters for 8592A

Type N(m) to APC 3.5 (f).	HP 1250-1744
Type N(m) to BNC(f).	HP 1250-0780

Test Procedure (50 kHz to 10 MHz)

1. Press the following keys on the analyzer:
PRESET (wait until the preset is complete)
[START FREQ] **0 kHz**
[STOP FREQ] **10 MHz**
AMPLITUDE 0 dBm
2. Set the HP 3335A Frequency Synthesizer to a CW output of 6.0 MHz at 0 dBm. Connect the equipment as shown in Figure 3-2 (a).

-
3. Tune the frequency synthesizer to place the signal at the center of the analyzer's screen. Set the sweep width of the frequency synthesizer to 11.95 MHz.
 4. Press [LOG dB/DIV] **1 +dBm** on the analyzer. Adjust the output power of the frequency synthesizer to place the signal at two divisions below reference level line.
 5. Press GO TO START FREQ on the frequency synthesizer. Press **FREQUENCY** and turn the RPG to position the signal at the left edge of the CRT graticule. Then press **TRACE A [MAX HOLD A]** on the analyzer.
 6. Start a 50-second single sweep in the frequency synthesizer. Repeat 50 second sweep three times to get smooth trace. At the end of the third sweep, press [VIEW A] on the analyzer.
 7. The frequency response flatness is the maximum peak-to-peak trace variation on the spectrum analyzer's screen. This variation should be less than 2.0 dB. Record the results on a copy of the test record.

Test Procedure (10 MHz to 2.9 GHz)

1. Press the following keys on the analyzer:
PRESET (wait until the preset is complete)
FREQUENCY
[START FREQ] **1 0 MHz**
[STOP FREQ] **2 9 0 0 MHz**
AMPLITUDE 0 +dBm
[LOG dB/DIV] **1 dB**
2. Set the HP 8340A Synthesized Sweeper to CW 300 MHz, then set the power level to +3 dBm.
3. Calibrate the power meter using HP 8485A power sensor.
4. Connect the recommended equipment as shown in Figure 3-2.
5. Adjust the output power of the synthesized sweeper to position the 300 MHz signal two divisions down from the analyzer's reference level. After setting the synthesized-sweeper to CW frequency and setting power level, place power meter in the RANGE HOLD mode.
6. On the analyzer, press **TRACE A** and [MAX HOLD A].
7. Set the synthesized sweeper's start frequency to 10 MHz and the stop frequency to 2900 MHz. Set synthesized sweeper sweep time to 200 seconds.
8. On the synthesized sweeper, press **TRIG [SINGLE SWEEP]** to start and complete one sweep. Repeat until three sweeps have been made on the analyzer.
9. On the analyzer, press [VIEW A] to store the display.

-
10. Press **MKR** and [MARKER NORMAL]. Adjust the tuning knob to place the marker on the 299.9 MHz calibration peak.
 11. Press [MARKER DELTA] and adjust the tuning knob to place the marker at the lowest point on the trace.
 12. Read the amplitude difference (direct readout displayed in both the active function block and marker readout areas of the screen).
 13. Adjust the tuning knob to place the marker at the highest point on the trace.
 14. Read the displayed amplitude difference.
 15. The frequency response flatness is the maximum peak to peak trace variation on the spectrum analyzer's screen. This variation should be less than ± 2.0 dB, referenced to the 299.9 MHz CAL signal.
 16. Record the test results on copies of Table 3-8 Frequency Response Flatness, and Table 3-9, Operation Verification Test Record.

2.75 GHz to 22 GHz

17. Press **FREQUENCY** [HRM LOCK] [2.75-6.2 BAND 1].
18. Set synthesized sweeper to START FREQUENCY of 3.0 GHz and STOP FREQUENCY of 6.0 GHz.
19. Verify that the HP 8485A power sensor is now in use.
20. Calibrate power meter and zero sensor; set CAL FACTOR on the power meter to sensor value at the center of the frequency band, i.e., 4 GHz value.
21. Connect HP 8485A to output of 11667B power splitter.
22. Press CW on the synthesized sweeper and set frequency to 3.5 GHz. Press analyzer **AMPLITUDE** and set reference level for -0 dBm. Adjust synthesized-sweeper output power to position signal two divisions down from analyzer reference level.
23. On the analyzer press **AMPLITUDE** [PRESEL PEAK]. When preselection routine is complete, press **MKR** [MARKERS OFF] **TRACE A** [CLEAR/WRITE A] [MAX HOLD A].
24. On the synthesized sweeper press single sweep to start and complete one sweep. Repeat until three sweeps have been made on the analyzer.
25. On the analyzer, press [VIEW A] to store the display.
26. Press **MKR** and [MARKER NORMAL]. Adjust the tuning knob to place the marker on the trace maximum.

27. Press [MARKER DELTA] and adjust the tuning knob to place the marker at the lowest point on the trace.
28. Read the amplitude difference (direct readout displayed in both the active function block and marker readout areas of the screen).
29. The frequency response flatness is the maximum peak to peak trace variation on the spectrum analyzer's screen. This variation should be within the values shown in Table 3-8.
30. Record the test results on copies of Table 3-8, Frequency Response Flatness, and Table 3-9, Operation Verification Test Record.
31. For the remaining harmonic bands, i.e., 6.0-12.8 GHz, 12.4-19.4 GHz and 19.1-22 GHz, repeat steps 17 through 30. Set the START and STOP frequencies of the synthesized-sweeper and the analyzer to the harmonic band limits. Set the CW frequency to mid-band and press [PRESEL PEAK].
32. For harmonic band 4, 19.1-22 GHz, set the CRT scale to 2 dB/Division Log, i.e., press **AMPLITUDE** [LOG dB/DIV] **2 dB**. Readjust the power output of the synthesized-sweeper to position signal two divisions down from CRT reference level.

Test Results

Table 3-8. Frequency Response Flatness

Test Description	Results		
	Minimum	Actual	Maximum
Frequency Response Flatness			
50 kHz to 2.9 GHz		_____	± 2.0 dB
2.75 to 6.2 GHz		_____	± 2.0 dB
6.0 to 19.4 GHz		_____	± 3.5 dB
12.4 to 19.4 GHz		_____	± 4.0 dB
19.1 to 22 GHz		_____	± 5.0 dB

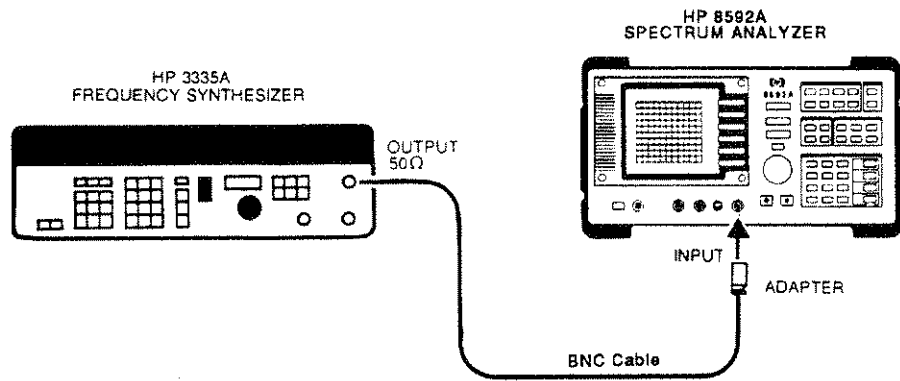

(a) 50 kHz to 10 MHz

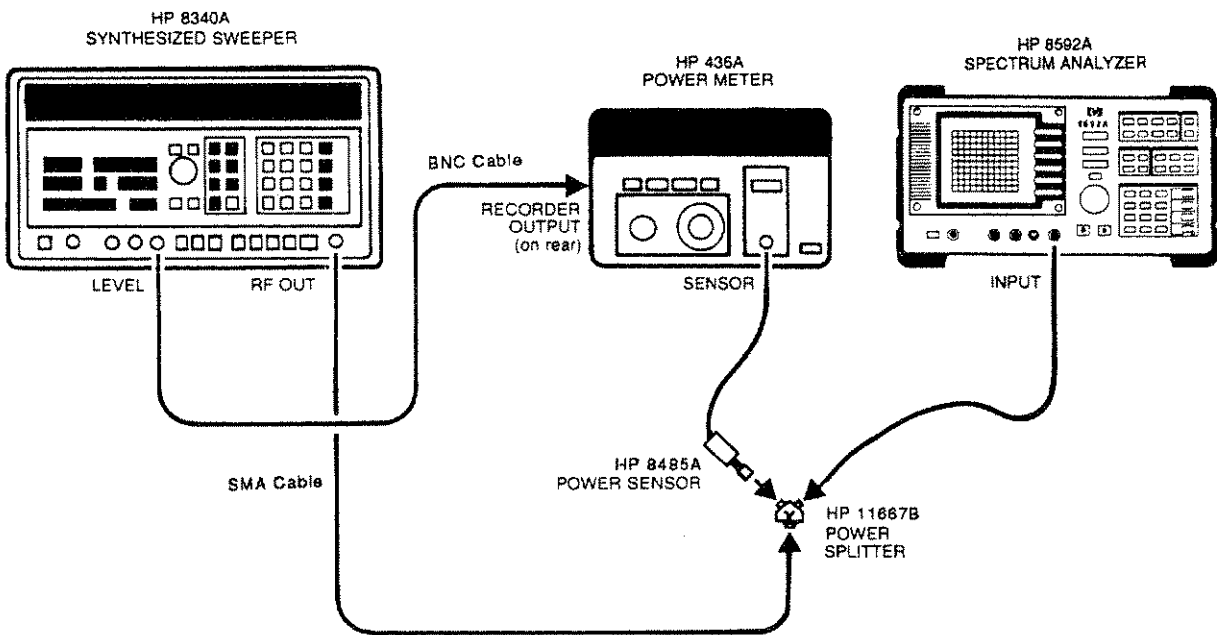

(b) 10 MHz to 22 GHz

Figure 3-2. Test Setup—Frequency Response Flatness

Table 3-9. Operation Verification Test Record

Hewlett-Packard Company HP Model 8592A		Tested by _____	
Spectrum Analyzer 50 kHz to 22 GHz		Date _____	
		Serial No. _____	
Test Description	Results		
	Min.	Actual	Max
Calibrator Amplitude 50 ohms: -20 dBm	-21 dBm	_____	-19 dBm
Frequency Accuracy 299.9 MHz	299.6 MHz	_____	300.2 MHz
Displayed Average Noise 400 kHz		_____	-88.48 dBm
10 MHz		_____	-109 dBm
1450 MHz		_____	-109 dBm
2900 MHz		_____	-109 dBm
2700 MHz		_____	-105 dBm
4500 MHz		_____	-105 dBm
6200 MHz		_____	-105 dBm
6000 MHz		_____	-99 dBm
9250 MHz		_____	-99 dBm
12800 MHz		_____	-99 dBm
12400 MHz		_____	-92 dBm
18500 MHz		_____	-92 dBm
19400 MHz		_____	-92 dBm
19100 MHz		_____	-87 dBm
22000 MHz		_____	-87 dBm
Frequency Span Readout Accuracy 50 kHz	38.00 kHz	_____	42.00 kHz
100 kHz	76.00 kHz	_____	84.00 kHz
500 kHz	380.00 kHz	_____	420.00 kHz
1 MHz	760.00 kHz	_____	840.00 kHz
100 MHz	98.00 MHz	_____	102.00 MHz
500 MHz	392.00 MHz	_____	408.00 MHz
1000 MHz	882.00 MHz	_____	918.00 MHz
2000 MHz	1862.00 MHz	_____	1938.00 MHz

- Table 3-9 continued on next page -

Table 3-9. Operation Verification Test Record (continued)

Hewlett-Packard Company HP Model 8592A		Tested by _____	
Spectrum Analyzer 50 kHz to 22 GHz		Date _____	
		Serial No. _____	
Test Description	Results		
	Min.	Actual	Max
Frequency Readout Accuracy			
1 MHz	0.0 MHz	_____	2.01 MHz
4 MHz	0.0 MHz	_____	8.01 MHz
50 MHz	44.80 MHz	_____	55.20 MHz
100 MHz	94.80 MHz	_____	105.20 MHz
500 MHz	494.80 MHz	_____	505.20 MHz
1000 MHz	994.80 MHz	_____	1005.20 MHz
2000 MHz	1994.80 MHz	_____	2005.20 MHz
4000 MHz	3991.80 MHz	_____	4008.20 MHz
9000 MHz	8981.80 MHz	_____	9018.20 MHz
16000 MHz	15962.80 MHz	_____	16032.20 MHz
20000 MHz	19959.80 MHz	_____	20040.20 MHz
Frequency Response Flatness			
50 kHz to 2.9 GHz		_____	<±2.0 dB
2.75 GHz to 6.2 GHz		_____	<±2.0 dB
6.0 GHz to 19.4 GHz		_____	<±3.5 dB
12.4 GHz to 19.4 GHz		_____	<±4.0 dB
19.1 GHz to 22 GHz		_____	<±5.0 dB

CHAPTER 4

IF SOMETHING GOES WRONG

What You'll Find in This Chapter

Your Spectrum Analyzer is built to provide dependable service. It is unlikely that you will experience a problem with the analyzer. However, if you do, or if you desire additional information or wish to order parts, options, or accessories, HP's worldwide sales and service organization is ready to provide the support you need.

In general, a problem can be caused by a hardware failure, a software error, or a user error. Follow these general steps to determine the cause and to resolve the problem:

- perform the quick checks listed in the following "Check the Basics" section; these checks may eliminate the problem altogether, or may give a clearer idea of its cause
- if the problem is a hardware problem, you have several options:
 - repair it yourself; see the "Service Options" section
 - return the analyzer to HP for repair;
 - if the analyzer is still under warranty or is covered by an HP maintenance contract, it will be repaired under the terms of the warranty or plan (the warranty is printed on the inside front cover of this **manual**)
 - if the analyzer is no longer under warranty or covered by an HP maintenance plan, HP will notify you of the cost of the repair after examining the unit

Also see the "How to Call HP" and "How to Return Your Analyzer for Service" paragraphs for more information.

Before You Call HP

Check the Basics

A problem often can be solved by rechecking what was being done when the problem occurred. A few minutes spent in performing some simple checks may save waiting for your instrument to be repaired. Before calling HP or returning the spectrum analyzer for service, please make the following checks:

- Is the analyzer plugged in to the proper ac power source? Does the line socket have power?
- Is the rear-panel voltage selector switch set correctly? Is the line fuse good?
- Is the analyzer turned on?
- If other equipment, cables, and connectors are being used with the analyzer, are they connected properly and operating correctly?
- Review the procedure for the test being performed when the problem appeared. Are all the switch settings correct?
- Is the test being performed, and the results that are expected, within the specifications and capabilities of the analyzer? (See Chapter 1, Table 1-1, for analyzer specifications.)
- Is the analyzer displaying an error message? If so, refer to Appendix A.
- Are the analyzer's measurements obviously inaccurate? If so, the analyzer's calibration data may have been destroyed. Refer to the Support Manual or contact the nearest Hewlett-Packard Sales and Service Office listed in Table 4-1.
- Perform the frequency and amplitude calibration routines given in the "Turning the Analyzer On for the First Time" paragraph in Chapter 2. After running these routines, perform the Confidence Test that is described in the same paragraph. Record all error messages that appear.
- If the necessary test equipment is available, perform the Operation Verification tests given in Chapter 3. Record all results on an Operation Verification Test Record located at the end of Chapter 3.

Read the Warranty

The warranty for your Spectrum Analyzer is printed on the inside front cover of this manual. Please read it and become familiar with its terms.

If your analyzer is covered by a separate maintenance agreement, please be familiar with its terms.

Service Options

HP offers several optional maintenance plans to service your analyzer after the warranty has expired. Call your HP Sales and Service office for full details.

If you want to service the analyzer yourself after the warranty expires, you can purchase a Service Documentation Package that provides all necessary test and maintenance information. You can order the Service Documentation Package through your HP Sales and Service office. The package is described under "Service Documentation (Option 915)" in Chapter 1 of this manual.

How to Call HP

Hewlett-Packard has Sales and Support offices around the world to provide you with complete support for your analyzer. To obtain servicing information or to order replacement parts, contact the nearest Hewlett-Packard Sales and Service Office listed in Table 4-1. In any correspondence or telephone conversations, refer to the instrument by its model number and full serial number. With this information, the HP representative can quickly determine whether your unit is still within its warranty period.

Table 4-1. HP Spectrum Analyzer Service Offices

<p>IN THE UNITED STATES</p> <p>California Hewlett-Packard Co. P.O. Box 4230 1421 South Manhattan Ave. Fullerton, CA 92631 (714) 999-6700</p> <p>Hewlett-Packard Co. 333 Logue Ave. Mountain View, CA 94040 (415) 969-0880</p> <p>Colorado Hewlett-Packard Co. 24 Inverness Place, East Englewood, CO 80112 (303) 649-5000</p> <p>Georgia Hewlett-Packard Co. P.O. Box 105005 2000 South Park Place Atlanta, GA 30339 (404) 955-1500</p> <p>Illinois Hewlett-Packard Co. 5201 Tollview Drive Rolling Meadows, IL 60008 (312) 255-9800</p> <p>New Jersey Hewlett-Packard Co. 120 W. Century Road Paramus, NJ 07653 (201) 265-5000</p> <p>Texas Hewlett-Packard Co. 930 E. Campbell Rd. Richardson, TX 75081 (214) 231-6101</p>	<p>IN AUSTRALIA Hewlett-Packard Australia Ltd. 31-41 Joseph Street Blackburn, Victoria 3130 895-2895</p> <p>IN CANADA Hewlett-Packard (Canada) Ltd. 17500 South Service Road Trans-Canada Highway Kirkland, Quebec H9J 2X8 (514) 697-4232</p> <p>IN FRANCE Hewlett-Packard France F-91947 Les Ulis Cedex Orsay (6) 907-78-25</p> <p>IN GERMAN FEDERAL REPUBLIC Hewlett-Packard GmbH Vertriebszentrale Frankfurt Berner Strasse 117 Postfach 560 140 D-6000 Frankfurt 56 (0611) 50-04-1</p> <p>IN GREAT BRITAIN Hewlett-Packard Ltd. King Street Lane Winkersley, Wokingham Berkshire RG11 5AR 0734 784774</p> <p>IN OTHER EUROPEAN COUNTRIES Hewlett-Packard (Schweiz) AG Allmend 2 CH-8967 Widen (Zurich) (0041) 57 31 21 11</p>
---	---

Table 4-1. HP Spectrum Analyzer Service Offices (continued)

<p>IN JAPAN Yokogawa-Hewlett-Packard Ltd. 29-21 Takaido-Higashi, 3 Chome Suginami-ku Tokyo 168 (03) 331-6111</p> <p>IN PEOPLE'S REPUBLIC OF CHINA China Hewlett-Packard, Ltd. P.O. Box 9610, Beijing 4th Floor, 2nd Watch Factory Main Bldg. Shuang Yu Shu, Bei San Huan Rd. Beijing 28-0567</p>	<p>IN SINGAPORE Hewlett-Packard Singapore Pte. Ltd. #08-00 Inchcape House 450-2 Alexandra Road Alexandra P.O. Box 58 Singapore, 9115 4731788</p> <p>IN TAIWAN Hewlett-Packard Taiwan 8th Floor, Hewlett-Packard Building 337 Fu Hsing North Road Taipei (02) 712-0404</p> <p>IN ALL OTHER LOCATIONS Hewlett-Packard Inter-Americas 3200 Hillview Avenue Palo Alto, California 94304</p>
--	--

How to Return Your Analyzer for Service

Service Tag

If you are returning the analyzer to Hewlett-Packard for servicing, fill in and attach a blue service tag. Several service tags are supplied at the rear of this manual. Please be as specific as possible about the nature of the problem. If you have recorded any error messages that appeared on the screen, or have completed a Performance Test Record, or have any other specific data on the performance of the analyzer, please send a copy of this information with the unit.

Original Packaging

Before shipping, pack the unit in the original factory packaging materials if they are available. If the original materials were not retained, identical packaging materials are available through any Hewlett-Packard office. Descriptions of the packaging materials are listed in Chapter 2, "Getting Ready."

Other Packaging

CAUTION

Analyzer damage can result from using packaging materials other than those specified. Never use styrene pellets in any shape as packaging materials. They do not adequately cushion the equipment or prevent it from shifting in the carton. They cause equipment damage by generating static electricity and by lodging in the analyzer fan.

You can repack the instrument with commercially available materials, as follows:

1. Attach a completed service tag to the instrument.
2. If you have a front-panel cover, install it on the instrument; if not, protect the control panel with cardboard.
3. Wrap the instrument in anti-static plastic to reduce the possibility of damage caused by electrostatic discharge.
4. Use a strong shipping container. A double-walled, corrugated cardboard carton with 159-kg (350-lb) bursting strength is adequate. The carton must be both large enough and strong enough to accommodate the analyzer. Allow at least three to four inches on all sides of the analyzer for packing material.
5. Surround the equipment with three to four inches of packing material and prevent the equipment from moving in the carton. If packing foam is not available, the best alternative is S.D.-240 Air Cap™ from Sealed Air Corporation (Commerce, California, 90001). Air Cap looks like a plastic sheet filled with 1-1/4 inch air bubbles. Use the pink-colored Air Cap to reduce static electricity. Wrapping the equipment several times in this material should both protect the equipment and prevent it from moving in the carton.
6. Seal the shipping container securely with strong nylon adhesive tape.
7. Mark the shipping container "FRAGILE, HANDLE WITH CARE" to assure careful handling.
8. Retain copies of all shipping papers.

APPENDIX A

Screen Messages

The analyzer can generate various messages that appear on its screen during operation to provide an indication of progress through a procedure or to indicate a problem.

There are three types of messages: hardware error messages (H), user-created error messages (U), and informational messages (M).

- Hardware error messages indicate the analyzer hardware is probably broken.
- User-created error messages appear when the analyzer is used incorrectly. They are usually generated during remote operation.
- Informational messages indicate analyzer progress within a specific procedure.

The messages are listed in alphabetical order on the following pages; each message is defined, and its type is indicated by an (H), (U), or (M). In several instances, you are referred to the command description (for example, "See the AUNITS command"). These command descriptions are contained in the Programming Manual.

ADC-GND FAIL

Indicates a failure in the processor - A/D $\pm 15V$ supplies can cause ADC-GND and ADC-2V. (H)

ADC-TIME FAIL

Indicates a failure in the processor - A/D A +5V supply can cause this. (H)

ADC-2v FAIL

Indicates a failure in the processor - A/D $\pm 15V$ supplies can cause ADC-GND and ADC-2V. (H)

CAL: FM SPAN SENS FAIL

The analyzer could not set up span sensitivity of the FM coil. (H)

CAL: LINEAR DET FAIL

The linear calibration routine failed. (H)

CAL: RES BW AMPL FAIL

The relative insertion loss of the resolution bandwidth is incorrect. (H)

CAL: SPAN SENS FAIL

The calibration span sensitivity routine failed. (H)

CAL:

During the calibration routine, messages may appear on the display indicating the routine is progressing: MC DELAY, FM DELAY, DONE, SWEEP, SWP DELAY, FREQ, SPAN, AMPTD, 3dB BW, ATTEN, LOG AMP, PEAKING, YTF. (M)

COMMAND ERROR:

The specified command is not recognized by the analyzer. The analyzer will recognize the commands described in Chapter 4 of the Programming Manual. (U)

CONFLICT TABLE OVERFLOW

A command has been used that is not compatible with the analyzer. (U)

FAIL:

An error was discovered during the power-up check. The 4-digit by 8-digit code indicates the type of error. Error codes are described in the Support Manual. (H)

INVALID AUNITS:

The amplitude units are not valid. See the AUNITS command. (U)

INVALID DETECTOR:

The specified detector is not valid. See the DET command. (U)

INVALID ENTER FORMAT

The enter format is not valid. See the appropriate command description to determine the correct format. (U)

INVALID HP-IB ADDRESS OR OPERATION

An HP-IB operation was aborted due to an incorrect address or invalid operation. (U)

INVALID HP-IB OPERATION REN TRUE

The HP-IB operation is not allowed. (Usually caused by print/plot when a calculator is on the interface bus.) (U)

INVALID HP-IL ADDRESS OR OPERATION

An HP-IL operation was aborted due to an incorrect address or invalid operation. (U)

INVALID HP-IL OPERATION REN TRUE

The HP-IL operation is not allowed. (Usually caused by print/plot when a calculator is on the interface bus.) (U)

INVALID OUTPUT FORMAT

The output format is not valid. See the appropriate command description to determine the correct format. (U)

INVALID RS-232 ADDRESS OR OPERATION

An RS-232 operation was aborted due to an incorrect address or invalid operation. (U)

INVALID TRACE:

The specified trace is invalid. See trace commands (VIEW, MXMH, CLRW or BLANK). (U)

INVALID TRIGGER MODE:

The specified trigger mode is invalid. See the TM command. (U)

INVALID WINDOW TYPE:

The specified window is invalid. See the TWINDOW command. (U)

MEAS UNCAL

The measurement is uncalibrated. Check the sweep time, span, and bandwidth settings. (U)

PARAMETER ERROR:

The specified parameter is not recognized by the analyzer. See the appropriate command description to determine the correct parameters. (U)

SRQ

The specified service request is active. Service requests are a form of informational message and are explained in Appendix B of the Installation Manual. (M)

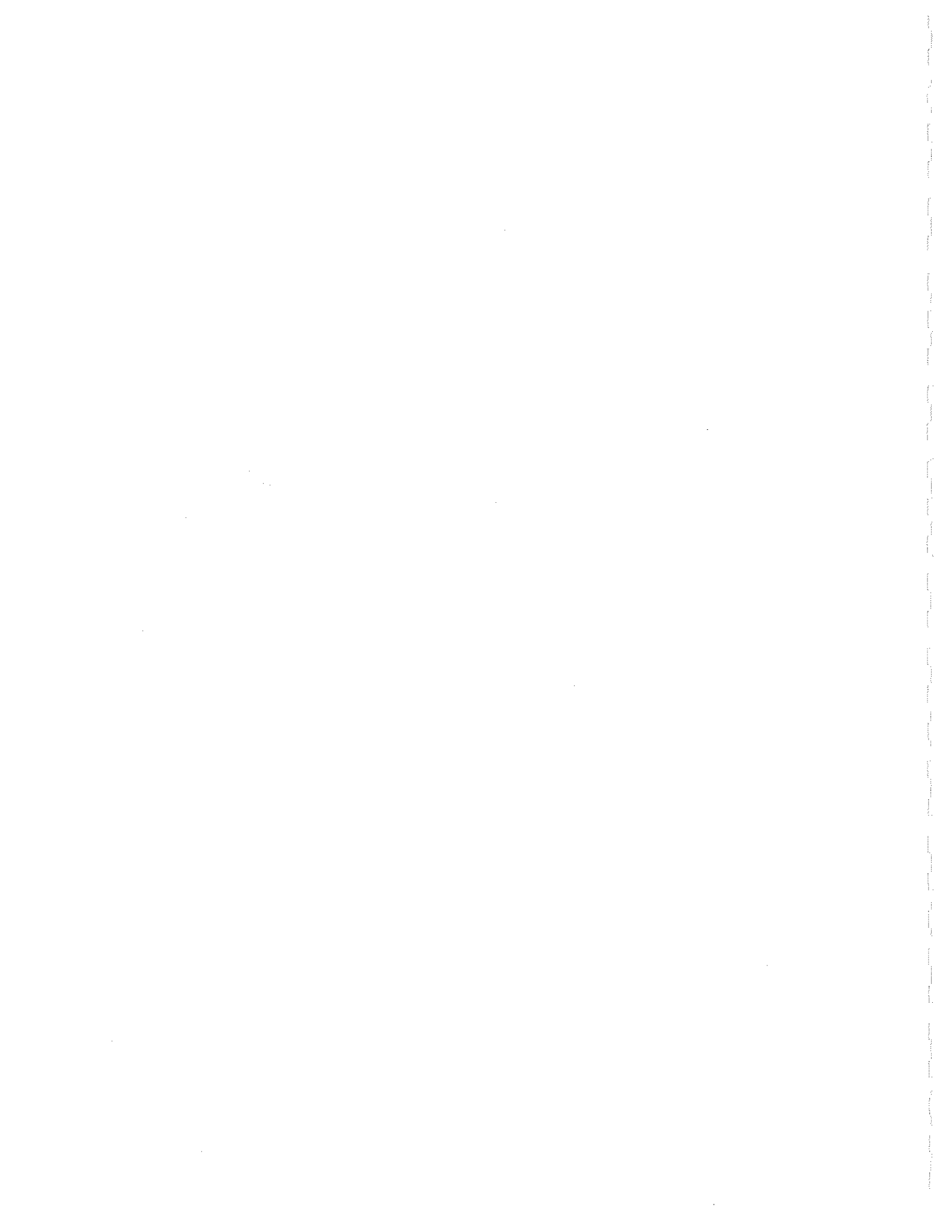

APPENDIX B

Service Requests

This appendix describes the analyzer service request (SRQ) capability. A service request is an analyzer output that tells the operator or computer that a specific event has taken place in the analyzer.

When writing programs, service requests can be used to interrupt the computer program sequence, causing the program to branch to a subroutine. For example, by using service requests, the computer can perform other operations while the analyzer is sweeping. When the sweep is completed, the computer can service the analyzer by changing the analyzer state or reading data from the display memory.

Note: Service requests do not work with computers that have only an RS-232 interface. HP-IB and HP-IL computers do not all have the same service request capabilities. Refer to the manuals supplied by your computer's manufacturer.

When making a service request, the analyzer places the I/O interface SRQ line true and the analyzer CRT display reads out SRQ with a number. Setting the SRQ line true announces to the computer that the analyzer requires attention. The computer can then command the analyzer to send its "status byte." The status byte indicates the type of service request.

Note: If the CRT display annotation has been blanked, the service request notation will not appear.

Note: A serial polling technique must be used by the computer to test for service requests. The analyzer does not respond to parallel polling.

Status Byte Definition

The status byte sent by the analyzer determines the nature of the service request. The meaning of each bit of the status byte is explained in Table B-1.

Table B-1. Status Byte Definition

Bit	Message	CRT Display Message
0 (LSB)	Unused	—
1	Unit Key	SRQ 102
2	End of sweep	SRQ 104
3	Hardware broken	SRQ 110
4	Command complete	SRQ 120
5	Illegal analyzer command	SRQ 140
6	Universal HP-IB service request HP-IB RQS bit	—
7	Unused	—

The CRT display message is an octal number based on the binary value of the status byte. This octal number always begins with a "1" since this is translated from bit 6, the universal service request bit. The status byte for an illegal analyzer command (SRQ 140) is as follows:

bit number	7	6	5	4	3	2	1	0
status byte	0	1	1	0	0	0	0	0

The CRT displays the octal equivalent of the status byte binary number:

SRQ 140

The octal equivalent is based on the whole binary number:

01100000 (binary) = 140 (octal)

One simple way to determine the octal equivalent of the binary number is to partition the binary number three bits at a time from the least significant bit, and treat each part as a single binary number:

binary	0	1	1	0	0	0	0	0
octal	1	4						0

The decimal equivalent of the octal number is determined as follows:

$$140 \text{ (octal)} = 1 * (8) + 4 * (8) + 0 * (8) = 96 \text{ (decimal)}$$

More than one service request can be sent at the same time. For example, if an illegal analyzer command (SRQ 140) and the end of a sweep (SRQ 104) occurred at the same time, SRQ 144 appears on the CRT display, because both bit 5 and bit 2 are set as shown below:

bit number	7	6	5	4	3	2	1	0	
status byte	0	1	1	0	0	1	0	0	= "SRQ 144"
octal value		1	4			4			

Service Request Activating Commands

With the exceptions of SRQ 140 and SRQ 102, service requests can only be activated from a computer. (SRQ 140 and SRQ 102 are always activated.) Your Programming Manual describes service request activating commands in Chapter 4 under RQS and SRQ.

Index

Accessories	1-3, 3-3
50-Ohm/75-Ohm Minimum-Loss Pad	1-5
75-Ohm Matching Transformer	1-5
Broadband Preamplifier	1-4
Close Field Probe	1-4
Computer	1-4
Monitor	1-4
Plotter	1-4
Printer	1-5
Rack Slide Kit	1-5
RF Limiter	1-5
Transit Case	1-5
AC Power	
Cables	2-4
Fuse	2-4
Requirements	2-4
Voltage Selector Switch	2-1,3
Amplitude Calibration Routine	2-6
Analyzers Covered By This Manual	1-6
Before You Call HP	4-2
Before You Start Operation Verification	3-2
Cable, AC Power	2-4
Calibration Routines	
Amplitude	2-6
Frequency	2-6
Calibrator Amplitude and Frequency Accuracy Test	3-6
Case, Transit	1-5
Characteristics	1-7
Check the Basics	4-2
Checking the Fuse	2-4
Close Field Probe	1-4
Confidence Test	2-1
Displayed Average Noise Test	3-8
Electrostatic Discharge	9
Equipment Rack	2-1
Error Messages	A-1
Frequency Calibration Routine	2-6
Frequency Readout Accuracy Test	3-16
Frequency Response Flatness Test	3-18
Frequency Span Readout Accuracy Test	3-12
Front-Panel Cover (Option 040)	1-3
Fuse	2-4

Getting Ready	2-1
How to Call HP	4-3
How to Return Your Analyzer for Service	4-6
How to Use This Manual	3
HP-IB (Option 021)	1-3
HP-IL (Option 022)	1-3
If the Analyzer Doesn't Meet Specifications	3-3
Initial Inspection	2-1
Inspection, Initial	2-1
Introducing the Spectrum Analyzer	1-2
Kit, Rack Slide	1-5
Limiter, RF	1-5
Line Voltage Selector Switch	2-3
Messages	A-1
Operating and Installation Manuals (Option 910)	1-4
Operation Verification	3-1
Operation Verification Test Record	3-23
Options	1-3
Front-Panel Cover (Option 040):	1-3
HP-IB (Option 021):	1-3
HP-IL (Option 022):	1-3
Operating and Installation Manuals (Option 910):	1-4
Rack Mount Flange Kit (Option 908):	1-3
Rack Mount Flange Kit With Handles (Option 909)	1-3
RS-232 (Option 023)	1-3
Service	4-3
Service Documentation (Option 915)	1-4
Options and Accessories Available	1-3
Original Packaging	4-6
Other Packaging	4-7
Packaging	
Original	2-3, 4-6
Other	4-7
Periodically Verifying Operation	3-3
Power Cable	2-4
Power Requirements	2-4
Preamplifier, Broadband	1-4
Preparing the Analyzer for Use	2-1
Probe	
Close Field	1-4

Procedures	
Amplitude Calibration Routine	2-6
Checking the Fuse	2-3
Confidence Test	2-6
Frequency Calibration Routine	2-6
Operation Verification	
Before Starting	3-2
Calibrator Amplitude and Frequency Accuracy	3-6
Displayed Average Noise	3-8
Frequency Readout Accuracy	3-16
Frequency Response Flatness	3-18
Frequency Span Readout Accuracy	3-12
Returning the Analyzer for Service	4-6
Setting the Line Voltage Selector Switch	2-3
Turning the Analyzer On for the First Time	2-6
Rack, Equipment	2-1
Rack Mount Flange Kit (Option 908)	1-3
Rack Mount Flange Kit with Handles (Option 909)	1-3
Recording the Test Results	3-3
Routine	
Amplitude Calibration	2-6
Frequency Calibration	2-6
RS-232 (Option 023)	1-3
SRQ (service request)	B-1
Safety	
Electrostatic Discharge	9
General Considerations	8
Static-Safe Accessories	10
Symbols	7
Serial Numbers	1-6
Service	
Documentation (Option 915)	1-4
How to Return Your Analyzer	4-6
Offices	4-4
Options	4-3
Service Requests (SRQ)	B-1
Service Request Activating Commands	B-3
Service Tag	4-6
Setting the Line Voltage Selector Switch	2-3
Specification	1-7
Static-Safe Accessories	10
Status Byte Definition	B-2
Switch, Line Voltage Selector	2-3
Symbols, Safety	7

Test	
Calibrator Amplitude and Frequency Accuracy	3-6
Confidence	2-1
Displayed Average Noise	3-8
Frequency Readout Accuracy	3-16
Frequency Response Flatness	3-18
Frequency Span Readout Accuracy	3-12
Test Equipment You'll Need	3-2
Test Record, Operation Verification	3-23
Test Results, Recording.	3-3
Turning the Analyzer On for the First Time.	2-6
Verification Tests	3-6
Voltage Selector Switch	2-3
Warranty	Inside Cover

HP 8592A Softkey Menus

FREQUENCY

BAND LOCK
 0-2.9 Gz BAND 0
 2.75-6.2 BAND 1
 6.0-12.8 BAND 2
 12.4-19.4 BAND 3*
 19.1-22 BAND 4
 HRM LOCK on/OFF
 COMB GEN on/OFF
 START FREQ
 STOP FREQ
 CF STEP SIZE
 FREQ OFFSET

SPAN

AMPLITUDE

ATTEN
 LOG dB/DIV
 LINEAR
 MAX MXR LEVEL
 REF LVL OFFSET
 PRESEL PEAK

Marker

MKR

MARKER NORMAL
 MARKER DELTA
 MARKER AMPTD
 MKNOISE on OFF
 MARKER PAUSE
 MARKERS OFF

MKR

MARKER→CF
 MARKER→RL
 MARKER→STEP
 MKR Δ →SPAN
 MORE →

PEAK SEARCH

MARKER→CF
 MARKER DELTA
 NEXT PEAK
 NEXT PK RIGHT
 NEXT PK LEFT
 PEAK EXCURSN

Instrument State

CAL

CAL FREQ
 CAL AMPTD
 CORRECT ON off
 CAL STORE
 CAL FETCH
 MORE
 DISPLAY CAL DATA
 CAL YTO DELAY
 CAL YTF
 VERT POSITION
 HORIZ POSITION
 CAL FLATNESS →

CONFIG

ANALYZER ADDRESS
 PLOTTER ADDRESS
 PRINTER ADDRESS
 BAUDRATE
 PREAMP GAN
 DISPOSE ALL

MENU 1

DELTA MEAS
 PK-PK MEAS
 3rd ORD MEAS
 3dB POINTS
 6dB POINTS

MENU 2

99% PWR BW
 FFT MEAS
 MODULATN MEAS
 CORRECT TO COMB
 PEAK SEARCH
 NEXT PK RIGHT
 NEXT PK LEFT
 CLEAR OFFST
 CONTINUE
 ABORT

SET 20 dB ERR**
 EXECUTE TITLE
 ENTER FLT ERR
 STP GAIN ZERO
 EEPROM INIT
 DACS

SAVE

SAVE 0 TRACE A
 SAVE 1 TRACE A
 SAVE 2 TRACE A
 SAVE 3 TRACE A
 SAVE 4 TRACE A
 SAV LOCK on/OFF

RECALL

RECALL 0 TRACE B
 RECALL 1 TRACE B
 RECALL 2 TRACE B
 RECALL 3 TRACE B
 RECALL 4 TRACE A

